

Advanced Fire Training Manual





WARRANTY INFORMATION

The essential purpose of any sale or contract for sale of any of the products listed in the POTTER catalog or price list is the furnishing of that product. It is expressly understood that in furnishing said product, POTTER does not agree to insure the Purchaser against any losses the Purchaser may incur, even if resulting from the malfunction of said product.

POTTER warrants that the equipment herein shall conform to said descriptions as to all affirmation of fact and shall be free from defects of manufacture, labeling and packaging for a period of one (1) or five (5) year(s), depending on the product, from the invoice date to the original purchaser, provided that representative samples are returned to POTTER for inspection. The product warranty period is stated on the exterior of the product package. Upon a determination by POTTER that a product is not as warranted, POTTER shall, at its exclusive option, replace or repair said defective product or parts thereof at its own expense except that Purchaser shall pay all shipping, insurance and similar charges incurred in connection with the replacement of the defective product or parts thereof. This Warranty is void in the case of abuse, misuse, abnormal usage, faulty installation or repair by unauthorized persons, or if for any other reason POTTER determines that said product is not operating properly as a result of causes other than defective manufacture, labeling or packaging.

The Aforesaid Warranty Is Expressly Made In Lieu Of Any Other Warranties, Expressed Or Implied, It Being Understood That All Such Other Warranties, Expressed Or Implied, Including The Warranties Of Merchantability And Fitness For Particular Purpose Are Hereby Expressly Excluded. In No Event Shall Potter Be Liable To Purchaser For Any Direct, Collateral, Incidental Or Consequential Damages In Connection With Purchaser's Use Of Any Of The Products Listed Herein, Or For Any Other Cause Whatsoever Relating To The Said Products. Neither Potter Nor Its Representatives Shall Be Liable To The Purchaser Or Anyone Else For Any Liability, Claim, Loss, Damage Or Expense Of Any Kind, Or Direct Collateral, Incidental Or Consequential Damages Relative To Or Arising From Or Caused Directly Or Indirectly By Said Products Or The Use Thereof Or Any Deficiency, Defect Or Inadequacy Of The Said Products. It Is Expressly Agreed That Purchaser's Exclusive Remedy For Any Cause Of Action Relating To The Purchase And/or Use Of Any Of The Products Listed Herein From Potter Shall Be For Damages, And Potter's Liability For Any And All Losses Or Damages Resulting From Any Cause Whatsoever, Including Negligence, Or Other Fault, Shall In No Event Exceed The Purchase Price Of The Product In Respect To Which The Claim Is Made, Or At The Election Of Potter, The Restoration Or Replacement Or Repair Of Such Product.

Potter Electric Signal Company, LLC

5757 Phantom Drive Ste 125 • St. Louis, MO 63042 • 314-595-6900 • 800-325-3936

Table of Contents

Section 1: Introduction 1-1
 Manual Overview..... 1-1

Section 2: Fire Alarm System Requirements & System Overview..... 2-2
 Fire Safety Code & Standard Requirements 2-2
 Occupancy Classifications 2-3
 Fire System Equipment Components..... 2-5
 Sprinkler System Supervision Requirements..... 2-6
 Types of Fire Systems 2-6
 Conventional Systems 2-6
 Addressable Systems 2-7
 Analog/Addressable Systems..... 2-8

Section 3: System Wiring 3-9
 Circuit Types Overview 3-9
 Class B Circuits 3-9
 Class A Circuits..... 3-11
 End of Line Resistor Supervision..... 3-13
 Initiating Device Circuits (IDCs)..... 3-13
 Notification Appliance Circuits (NACs)..... 3-14
 Signaling Line Circuit Overview 3-15
 T-Tapping/Branch Circuits..... 3-17
 Isolator Devices 3-18
 RS-485 Connections 3-19

Section 4: Initiating Device Requirements..... 4-20
 Initiating Device Overview..... 4-20
 Installation Overview..... 4-20
 Manual Alarm Station Types..... 4-20
 Manual Alarm Station Installation Requirements..... 4-21
 Smoke Detectors..... 4-22
 Smoke Detector Installation Considerations 4-23
 Smoke Detectors in Residential Occupancies..... 4-25
 Residential Smoke Detector Types 4-25
 Residential Smoke Detector Location..... 4-25
 New Residential Installation Considerations..... 4-25
 Existing Residential Installation Considerations..... 4-26
 Air Duct Smoke Detectors..... 4-28
 Duct Detector Requirements..... 4-28
 Heat Detectors 4-29
 Heat Detector Types..... 4-29
 Heat Detector Installation Considerations..... 4-30
 Fire Sprinkler Panels..... 4-31

Section 5: Notification Appliances Requirements 5-32
 Notification Appliances Overview 5-32
 Audible Notification Requirements 5-33
 Average Ambient Sound Level Guidelines 5-33
 Multiple Rated Audio Devices..... 5-34
 Low-Frequency Sounder Requirements 5-34
 Other Audible Device Installation Considerations..... 5-35

<i>Public & Private Modes Occupancy Requirements</i>	5-36
Visual Notification Requirements	5-36
<i>Installation Orientation</i>	5-37
<i>Corridor Installation Requirements</i>	5-38
<i>Candela Light Output Rating</i>	5-38
<i>NFPA's Light Output Candela Requirements</i>	5-39
<i>Multiple Candela Rated Visual Devices</i>	5-40
Remote Annunciators.....	5-41
<i>Types of Annunciators</i>	5-41
Fire Alarm Signals	5-42
Section 6: Communications Technology	6-43
Digital Alarm Communicator Transmitter (DACT)	6-43
<i>DACT Overview</i>	6-43
<i>Equipment Requirements for DACT Communications</i>	6-43
<i>Transmission Requirements for DACTs</i>	6-44
IP Communications.....	6-45
<i>IP Communications Overview</i>	6-45
<i>IP Connection Types</i>	6-45
<i>Equipment Requirements for IP Communications</i>	6-45
<i>Transmission Requirements for IP Communications</i>	6-46
<i>Communication Path Requirements</i>	6-46
<i>Single Communication Path</i>	6-46
<i>Multiple Communication Paths</i>	6-46
Radio Systems.....	6-47
<i>Radio Systems Overview</i>	6-47
<i>Two-Way Radio Frequency (RF) Multiplex Systems</i>	6-47
<i>Equipment Requirements for Two-Way Radio</i>	6-47
<i>Transmission Requirements for Two-Way Radio Systems</i>	6-48
<i>One-Way Radio Frequency (RF) Systems</i>	6-48
<i>Equipment Requirements for One-Way Radio</i>	6-49
<i>Transmission Requirements for One-Way Radio Systems</i>	6-49
Comparison of DACT, IP & Radio System Communications.....	6-50
Section 7: Battery & SLC Calculation Worksheets / Submittal Documentation.....	7-52
Calculation Overview	7-52
<i>Notification Voltage Drop</i>	7-52
<i>Lump Sum Calculation Method</i>	7-53
Battery Standby Calculations.....	7-53
Submittal Documentation	7-55
Appendix A: Glossary & Definitions.....	A-56
Appendix B: Control Panel Symbols.....	B-62
Appendix C: Signal Initiating Devices & Switch Symbols.....	C-64
Appendix D: Signal Indicating Appliances & Related Equipment Symbols.....	D-67
Appendix E: System Installation & Troubleshooting Tips.....	E-68

Section 1: Introduction

The first standards for fire detection and alarm systems in the United States dates back to the 1800s. While these first fire alarms were simplistic, advances in technology have resulted in fire alarm systems that can be intimidating in their complexity. As fire alarm system technology continues to evolve, the basic functions of the fire alarm system remain unchanged. A firm understanding of these basic functions are the building blocks used by a system designer to configure today's modern fire alarm system.

Manual Overview

This manual provides a comprehensive overview of fire detection and alarm system components. Topics include types of detection, notification, and control panels. The manual also addresses submittal documentation that is required for the permit, installation and maintenance process. The table below summarizes the manual's content by section.

Table 1: Overview of Manual Content	
Section	Description
Section 2: Fire Alarm System Requirements & System Overview	Explains how codes and standards impact the selection and installation of fire alarm systems. You'll learn how the building occupancy class determines the equipment required for each facility. Types of fire alarm signals, and differences between conventional, addressable and analog/addressable fire alarm systems are also presented.
Section 3: System Wiring	Explains the differences between SLC Class A and Class B circuit wiring, use of isolators to provide greater system reliability, and other wiring options, i.e., initiating device circuits (IDCs), isolators, and T-tapping.
Section 4: Initiating Device Requirements	Provides details for properly installing smoke detectors based on location of air diffusers and fluorescent lighting fixtures, room dimensions, and other factors. Heat detector and manual pull station location requirements in commercial buildings, and standards for new and existing residential sleeping areas are also included.
Section 5: Notification Appliance Requirements	Explains the audible / visual notification appliance functions and requirements. Topics include types of NAC devices, minimum sound pressure (dB) levels for sleeping areas and public areas, light output measurement ratings (i.e., candela ratings), and others.
Section 6: Communications Technology	Provides an overview of communication technologies to send transmission signals between the fire control panel and monitoring or supervisory company. DACT, IP connections, and radio systems are addressed.
Section 7: Battery Calculation & SLC Worksheets / Submittal Documentation	Explains how to calculate standby and alarm battery requirements. Sample SLC and Battery worksheets are included for future reference. Submittal documentation required by AHJ and other local jurisdictions prior to installation are also addressed.
Appendix A: Glossary & Definitions	Provides definitions for standard fire system and sprinkler industry terms and concepts. These have been included for your convenience to supplement the information in this manual.
Appendix B: Control Panels Symbols	Provides a comprehensive table of control panel symbols.
Appendix C: Signal Initiating Devices & Switch Symbols	Provides a table showing signal initiating devices and switch symbols.
Appendix D: Signal Indicating Appliances & Related Equipment Symbols	Provides a table showing signal indicating appliances and related equipment symbols.
Appendix E: System Installation & Troubleshooting Tips	Provides system installation tips, common panel problems, possible causes and solutions.

Section 2: Fire Alarm System Requirements & System Overview

This section explains how fire alarm system requirements are determined and the variables that affect their application. For example, a building's occupancy class directly impacts the number and type of devices required. In addition, NFPA codes and standards, along with the Authorities Having Jurisdiction's (AHJ) requirements, must be met before a building's fire system installation is approved.

Note: Refer to *NFPA 101 Life Safety Code and NFPA 72 2013, Sections 3, 10, 17, 23 and 26* for more details on these topics.

An overview of the components that make up most fire detection and alarm systems, including the differences between conventional, addressable and analog/addressable fire systems are also covered in this section.

This section's information is particularly **important** to you as a system designer because it is your responsibility to:

- Observe all applicable codes and standards, including requirements specified by the AHJ (Authority Having Jurisdiction) to ensure that the installation provides the level of protection required at a facility.
- Select the correct fire system (*conventional vs. addressable*), detection and initiating devices, such as manual pull stations, automatic smoke or heat detectors, and other necessary appliances (*i.e., remote annunciators, mass notification devices, etc.*).
- Oversee the entire wiring and configuration or placement of all devices, modules and appliances (*refer to Sections 3 – 5 for this information*).
- Submit all required documentation, such as engineering and wiring diagrams, equipment specifications, and battery calculations to the AHJ prior to the installation (*refer to Section 7 for this information*).

Fire Safety Code & Standard Requirements

As a system designer, it's important to understand how to apply all fire safety code and standard requirements. This can be an overwhelming process, so this topic provides a brief overview of the differences between "codes" and "standards." It also includes a few examples of the more commonly used NFPA codes and standards. Some of these codes and standards are also referenced throughout the manual to reinforce your understanding of key concepts.

Fire safety "*codes*" and "*standards*" are similar in purpose, but are different in scope:

- **Codes** state the **minimum** requirements needed to provide a **reasonable** degree of life, health and fire safety.
- **Standards** focus on a **specific** building component or system.

The table below provides a brief summary of fire and safety codes and standards:

Table 2: Fire Alarm and Safety Codes & Standards	
CODES	STANDARDS
<ul style="list-style-type: none"> • Provides minimum requirements. • Codes specify "<i>When</i>" and "<i>Where</i>" certain types of protection are required (<i>i.e., hazardous environments, aircraft hangars, theaters, etc.</i>). • Codes are written rules and regulations that the AHJ adopt as law. 	<ul style="list-style-type: none"> • Provides guidance on proper installation, maintenance and testing. • Details "<i>How</i>" the components that provide the level of protection required by the Code should operate.
EXAMPLES	
NFPA 70 National Electrical Code contains electrical wiring protection requirements.	NFPA 72 National Fire Alarm Code contains signaling standards and requirements for fire system designers.
IBC International Building Code The International Building Code (IBC) is the foundation of the complete Family of International Codes®. It is an essential tool to preserve public health and safety that provides safeguards from hazards associated with the built environment.	NFPA 720: Standard for the Installation of Carbon Monoxide (CO) Detection and Warning Equipment This standard contains requirements for the selection, installation, operation, and maintenance of equipment that detects concentrations of carbon monoxide that could pose a life safety risk to most occupants in buildings and structures.
NFPA 101 Life Safety Code provides life safety requirements for all types of facilities.	NFPA 20 Standard for the Installation of Stationary Fire Pumps for Fire Protection covers the selection and installation of fire pump requirements for all building types ensuring that adequate and reliable water supplies are provided in fire emergencies.

Occupancy Classifications

Each building is given a occupancy classification as defined by the *NFPA 101 Life Safety Code*. This Code states the fire alarm and sprinkler requirements for each building type in "*Chapter 9.6: Fire Detention, Alarm, and Communications Systems.*" Some buildings fall into multiple occupancy classifications. When this occurs, refer to "*Chapter 6.1.14 Multiple Occupancies*" to ensure all requirements are met.

IMPORTANT NOTE! The "*Occupancy Class*" information applies only when the *NFPA 101 Life Safety Code* is the adopted Code being enforced.

The table below provides a list of occupancy classifications, descriptions and NFPA 101 Life Safety Code chapter references.

CLASSIFICATION	DESCRIPTION
Education Occupancy	<ul style="list-style-type: none"> • An occupancy used for educational purposes through the 12th grade by 6 or more persons for 4 or more hours per day or more than 12 hours per week. • See Chapters 12 & 13 in NFPA 101 for requirements.
Day Care Occupancy	<ul style="list-style-type: none"> • An occupancy in which 4 or more clients receive care, maintenance, and supervision, by other than the relatives or legal guardians, for less than 24 hours per day. • See Chapters 16 & 17 in NFPA 101 for requirements.
Health Care Occupancy	<ul style="list-style-type: none"> • An occupancy used to provide medical or other treatment or care simultaneously to 4 or more patients on an inpatient basis, where such patients are mostly incapable of self-preservation due to age, physical or mental disability, or because of security measure not under the occupants' control. • See Chapters 18 & 19 in NFPA 101 for requirements.
Ambulatory Health Care Occupancy	<ul style="list-style-type: none"> • An occupancy used to provide services or treatment simultaneously for 4 or more patients that provides, on a outpatient basis, one or more of the following: <ul style="list-style-type: none"> – Treatment that renders a patient incapable of taking action. – Anesthesia that renders a patient incapable of taking action. – Emergency or urgent care for patients who are incapable of taking action. • See Chapters 20 & 21 in NFPA 101 for requirements.
Detention and Correctional Occupancy	<ul style="list-style-type: none"> • An occupancy used to house one or more persons under varied degrees of restraint or security where such occupants are mostly incapable of self-preservation because of security measures not under the occupants' control. • See Chapters 22 & 23 in NFPA 101 for requirements.

Table 3: Building Occupancy Classifications

CLASSIFICATION	DESCRIPTION
<p>Residential Occupancy</p>	<ul style="list-style-type: none"> • An occupancy that provides sleeping accommodations for purposes other than health care or detention and correctional. <ul style="list-style-type: none"> – One-and Two-Family Dwellings – Lodging or Rooming House – Hotel – Dormitory – Apartment Building • See Chapters 24 – 31 in NFPA 101 for requirements.
<p>Residential Board and Care Occupancy</p>	<ul style="list-style-type: none"> • An occupancy used for lodging and boarding 4 or more residents, not related by blood or marriage to the owners or the operators, for the purpose of providing personal care services. • See Chapters 32 & 33 in NFPA 101 for requirements.
<p>Mercantile Occupancy</p>	<ul style="list-style-type: none"> • An occupancy used for the display and sale of merchandise. • See Chapters 36 & 37 in NFPA 101 for requirements.
<p>Business Occupancy</p>	<ul style="list-style-type: none"> • An occupancy used for the transaction of business other than mercantile. • See Chapters 38 & 39 in NFPA 101 for requirements.
<p>Industrial Occupancy</p>	<ul style="list-style-type: none"> • An occupancy in which products are manufactured or in which processing assembling, mixing, packaging, finishing, decorating, or repair operations are conducted. • See Chapter 40 in NFPA 101 for requirements.
<p>Storage Occupancy</p>	<ul style="list-style-type: none"> • An occupancy used primarily for the storage or sheltering of goods, merchandise, products, or vehicles. • See Chapter 42 in NFPA 101 for requirements.
<p><i>Note: When more than one type of occupancy exists for the same building, refer to NFPA 101 2013, Section 6.1.14 Multiple Occupancies, to ensure all requirements are met.</i></p>	

Fire System Equipment Components

Once the system designer has determined the *Building Occupancy Classification(s)* of a facility, the next step is to select the appropriate fire panel system (*i.e., addressable, conventional*), initiating, detection, notification devices and appliances, as well as extinguishing equipment and emergency notification.

Note: Refer to *NFPA 72 2013, Sections 10, 18, 23 and 26* for more information on these topics.

The table below summarizes how the building code classification drives the required fire system components.

Table 4: Fire System Equipment Components	
Equipment Type	Building Code Requirements / Equipment Options
Initiation Devices	<ul style="list-style-type: none"> • Building Codes state how the initiating devices should be activated (<i>i.e., manual vs. automatic</i>) and where they should be located. • There are three (3) methods for initiating an alarm: <ol style="list-style-type: none"> 1. <i>Manual</i> 2. <i>Automatic</i> 3. <i>Extinguishing System Operation</i>
Detection Devices	<ul style="list-style-type: none"> • The Building Code requirements should always be reviewed, even if the building class does not require detection devices. • There are two (2) types of detection devices: <ol style="list-style-type: none"> 1. <i>Manual, and</i> 2. <i>Automatic</i> • <i>Automatic detection devices</i> include any device that activates the fire alarm panel or directly activates a notification appliance without human intervention (<i>i.e., smoke detectors, heat detectors and water flow switches</i>). • <i>Manual fire detection</i> typically refers to pull stations that directly activates the fire alarm or suppression system. Manual fire detectors require human intervention.
Notification Devices & Related Equipment	<ul style="list-style-type: none"> • The Building Codes may designate that occupant notification is required to alert them of a fire or other emergency. If so, the Code will also state how to meet the requirements (<i>i.e., bells, beacons, pre-signal, etc.</i>). • There are a wide range of notification devices and related equipment, such as audible and visible signals, and voice evacuation.
Off-Premises Signals	<ul style="list-style-type: none"> • The Building Code may require monitoring equipment to provide immediate notification to the central station or fire department. • Some fire alarm systems have built-in monitoring capabilities while others do not (<i>i.e., DACT, IP reporting, etc.</i>).
Installation & Testing	<ul style="list-style-type: none"> • Building Codes state the minimum requirements for installing fire sprinklers, automatic extinguishing systems, fire extinguishers and standpipes. • Building Codes refer to appropriate NFPA Standards that must be followed and equipment trade-offs that are allowed (<i>i.e., NFPA 72 states equipment testing, maintenance and inspection requirements</i>).

Sprinkler System Supervision Requirements

When the occupancy class requires that fire sprinklers be installed, they may supervise one or more of the following:

- Water Supply Control Valves
- Alarm Line Supervision
- Fire Pump Status
- Water Tank, Levels and Temperature
- Low and High Air Pressure on Dry Pipe Systems
- Building Temperature

Notes:

1. Refer to *NFPA 72 2013, Sections 17.16.1–17.16.4* for more information on these topics.
2. Water supply control valves **must** be supervised to obtain a distinctive signal when in an "off normal" position, within two (2) revolutions of the hand wheel, or when the valve has moved one fifth from its normal position.
3. The switch **must not** restore to a normal condition throughout the entire travel of the valve, until it is restored to a fully open position.
4. A *Supervisory signal* **must** be visually or audibly distinctive from both Alarm and Trouble signals.
5. Water flow and supervisory devices cannot be connected on the same initiating circuit.

Types of Fire Systems

Fire systems are classified as either *conventional, addressable, or analog/addressable* based on their capabilities. This section describes those differences, and provides a few advantages and disadvantages to each system type. The system designer chooses the appropriate type of fire system for a facility based on financial constraints, desired protection level, building occupancy class, AHJ, and other factors.

Conventional Systems

Conventional fire alarm systems are comprised of *initiating and notification zones*. The number of initiating zones (*initiating device circuits*) defines how large the system can be. The zones are generally assigned to a specific function (*i.e., pull station, water flow switch, etc.*) or cover a geographical area for smoke and heat detection. Most conventional zones use a two-wire scheme with an end of line resistor for supervision commonly referred to as an *IDC (Initiating Device Circuit)*. The IDC connects an automatic or manual initiating device to a zone or a monitoring module.

Note: IDCs will be discussed in detail in "*Section 3: System Wiring - Initiating Device Circuits.*"

Conventional zones support two (2) types of devices:

1. **Dry Contact Devices** – these use a normally open switch which close on activation that creates an alarm.

Examples: pull stations, heat detectors, four wire smoke detectors, flow switches and sprinkler supervisory switches.

2. **2-Wire Smoke Detectors** – these use voltage from the panel for power and must be listed for compatibility.

- There are a maximum number of smoke detectors that can be installed on any zone.
- Most panels are listed with many different smoke detectors; the exact number of smokes per panel varies with each manufacturer.

When configuring devices, the NFPA 72 recommends the following:

- The coverage area for a single zone **does not** exceed 20,000 square feet and **does not** extend beyond a floor of a building.
- A maximum of five (5) waterflow switches and a maximum of twenty (20) supervisory switches can be connected to a single zone.
- The system's common devices should be grouped together in a zone.
- A trouble condition on a zone should indicate some sort of wiring or device problem.

Figure 1. Example of a conventional system. Potter's PFC-6006 Conventional Spinkler Monitoring Panel



Addressable Systems

Addressable fire alarm systems are more versatile and have more features than conventional systems. On these systems, each initiating device is assigned a **unique identification or address** (*i.e.*, *address = 001, 002, etc.*). Plus, these panels usually allow a device to have a descriptive name (*i.e.* *Address 1, Front Lobby, back door, hallway, etc*) that helps to quickly locate where the "off normal" condition(s) occurred. Addressable devices are similar to conventional devices since they are either in "alarm" or a "normal" condition.

Secondly, addressable systems use a *Signaling Line Circuit (SLC)* to communicate with detectors and modules. SLCs are a huge benefit because the fire panel can be expanded to perform more remote relay functions, dry contact monitoring, remote power control, releasing service and conventional zone monitoring.

Figure 2. Example of Potter's IPA-100 Addressable Fire System



SLCs provide 2-way communication between a device and the panel via a SLC circuit. The panel and a device "talk" to each other every 4–5 seconds, referred to as "polling." (*SLCs are discussed in more detail in Section 3: System Wiring.*)

Lastly, addressable panels allow *inputs to be mapped to outputs*. The term "*mapping*" refers to the relationships between devices, modules and sensors that can be created by the installer. Mapping also allows the behavior between each device to be programmed. For example, the installer controls the output of a device when a specific condition occurs, *i.e. alarm, trouble, etc.*

The table below summarizes the differences between addressable and conventional fire systems:

Features	Addressable System	Conventional System
Installation	Addressable systems use a <u>single</u> pair of wires that connects to <u>all</u> of the initiating devices and control modules.	The wiring for each initiating zone must return to the panel. An end of line resistor at the last device is installed to maintain supervision
Trouble Functionality	The panel provides detailed information to the installer, which helps in determining the source of the problem	The panel provides the zone where the trouble condition has occurred. However, only general information is provided.
Alarm Functionality	When an alarm condition occurs, panel shows which device is in alarm and its location.	When the alarm condition occurs, the panel shows which zone is in alarm.
Cost / Expense	Higher cost for addressable detectors and modules, but reduced time and expense for installation and cabling Allows for T-Tapping instead of home runs back to FACP.	Lower cost for detectors and other conventional devices. Increased time and expense for installation and cabling. All wiring <u>must</u> home run back to FACP.

Analog/Addressable Systems

Analog/Addressable systems are wired the same as a straight addressable system. However, they also provide additional features that assist in the testing and maintenance of a system. For example, the analog/addressable system uses a sensor for detecting a level of alarm, instead of a detector that is either in alarm or normal. Since the panel and sensors communicate, this allows the panel to determine if the device is normal, dirty or in alarm. An example of a "*sensitivity test*" is shown below.

Figure 3. Example of Potter 6000 Series Panel Sensitivity Test Exported to Excel

Address	Sensor Type	Sensor Name	Current Condition	Peak Value	Day Sensitivity	Night Sensitivity	Thermal Alarm Level	Drift Percentage	Drift Limit	Drift Alert	NFPA 72 Compliant
10	PHOTO-HEAT	1st Fl Elev Lobby	0.00% (000)	0.00%(000)	3.5% (055)	3.5% (055)	135F	0.00% (060)	1.80% (089)	OK	Yes
11	HEAT-FIXED	Elec Rm	68F	78F	n/a	n/a	150F	n/a	n/a	n/a	n/a
12	PHOTO	2nd Fl Elev Lobby	0.00% (000)	0.92%(015)	3.5% (055)	3.5% (055)	n/a	0.80% (073)	1.80% (089)	OK	Yes
13	HEAT-FIXED	Elec Rm	68F	77F	n/a	n/a	150F	n/a	n/a	n/a	n/a

Section 3: System Wiring

This section explains the different wiring methods that can be used on a fire alarm panel and how they affect the way the system is monitored. The type of wiring specifically impacts the system's ability to monitor the integrity of the circuits and how it responds when an alarm condition occurs.

After the system designer selects the appropriate fire system panel (*i.e., addressable, conventional*), they must next choose the type of wiring to connect devices, modules and other appliances. This decision directly impacts the system's level of reliability, life safety and protection achieved at a facility.

Note: Please refer to *NFPA 72 2013, Sections 12.3–12.6, 23.4–23.6, 3.3.133, and Appendix Tables F3, F1 & F2* for more information on these topics (*listed in order of relevance*).

Circuit Types Overview

Addressable system panels can be wired as either *Class A or Class B*. The *circuit type* determines how a break in the loop affects the system's operation. Several examples of Class A and B wiring are shown here.

Class B Circuits

Most fire alarm system installations use Class B circuits. They provide the minimum level of protection that most facilities require. Class B circuits are characterized by the following features:

1. The circuit does not include a redundant path.
2. A single open on the circuit will render the devices located behind the location of the open circuit inoperable.
3. Any condition that affects the operation of the circuit will be annunciated as a trouble signal at the fire alarm control panel.
4. A single ground fault will not render the circuit inoperable. The presence of a single ground fault will be annunciated at the fire alarm control panel.

When wiring a conventional panel Class B, an *End of Line Resistor* (EOLR) is required to supervise each conventional input zone as well as any NAC output. When wiring an addressable panel Class B, an EOLR is required to supervise the NACs and IDCs. However, the SLCs on an addressable panel does not need an EOLR to supervise the circuit. A SLC uses two-way communication between each device and the panel to monitor and supervise the circuit and device. This two-way communication also allows for t-tapping on SLCs.

Refer to the drawings below and the associated "Device Legend" for Class B wiring examples.

Figure 4. Class B EOLR Wiring Example on Conventional Panels

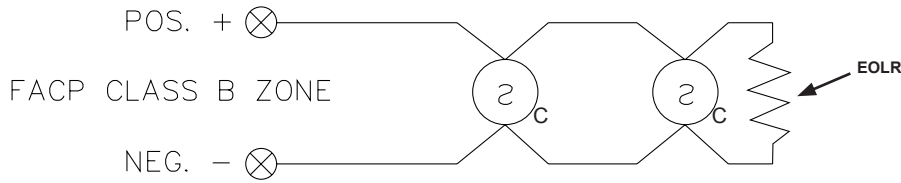

DWG. #55-2

Figure 5. Class B SLC Wiring Example on Addressable Panels

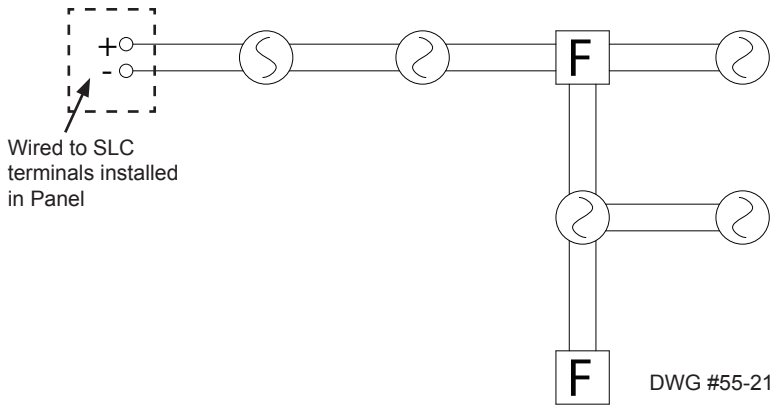

DWG #55-21

DEVICE LEGEND	
	ADDRESSABLE SMOKE DETECTOR
	CONVENTIONAL SMOKE DETECTOR
	ADDRESSABLE PULL STATION
	WATERFLOW SWITCH
	ADDRESSABLE MONITOR MODULE
	HORN/STROBE
	END OF LINE RESISTOR

Figure 6. Class B Wiring NAC Example on Conventional / Addressable Panels

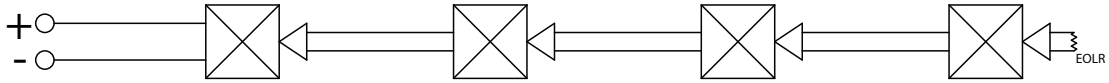

DWG #55-22

Class A Circuits

Class A circuits are used on certain types of installations (*i.e., government, schools, hospitals, etc.*), and when insurance authorities require it at a facility. Class A circuits can provide a higher level of system survivability.

Class A circuits are characterized by the following features:

1. The circuit includes a redundant path.
2. The circuit will remain operable when there is a single open. The open will annunciate the fire alarm control panel as a trouble condition.
3. Any condition that affects the operation of the circuit will be annunciated as a trouble signal at the fire alarm control panel.
4. A single ground fault will not render the circuit inoperable. The presence of a single ground fault will be annunciated at the fire alarm control panel.

Refer to the drawings below and the associated "Device Legend" for Class A wiring examples that illustrate supervision of NACs, IDCs or other devices on conventional and addressable panels.

In Class A wiring, the circuit is a continuous loop; t-tapping is not allowed and EOLRs are not required.

Figure 7. Class A Wiring Example on Conventional / Addressable Panels

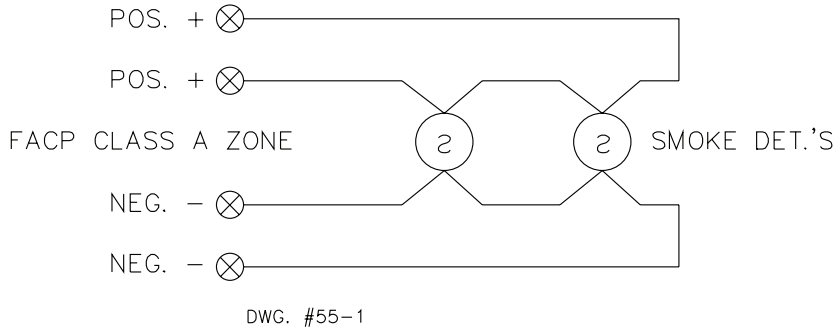
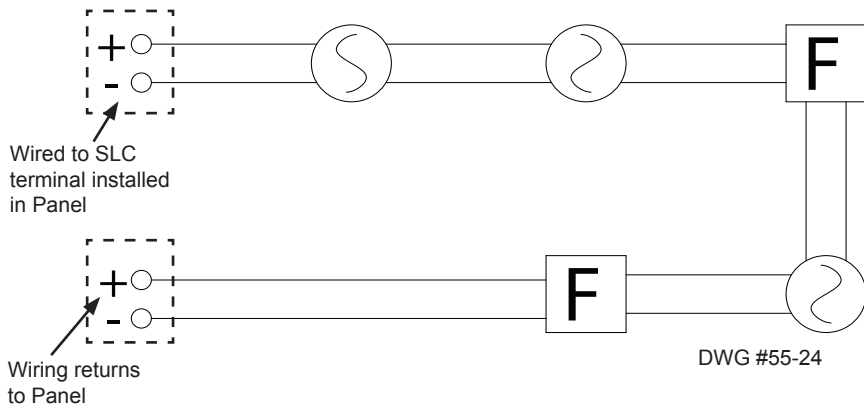

Figure 8. Class A SLC Wiring Example on Addressable Panels



DEVICE LEGEND	
	ADDRESSABLE SMOKE DETECTOR
	CONVENTIONAL SMOKE DETECTOR
	ADDRESSABLE PULL STATION
	WATERFLOW SWITCH
	ADDRESSABLE MONITOR MODULE
	HORN/STROBE
	END OF LINE RESISTOR

Figure 9. Class A NAC Wiring Example on Conventional / Addressable Panels

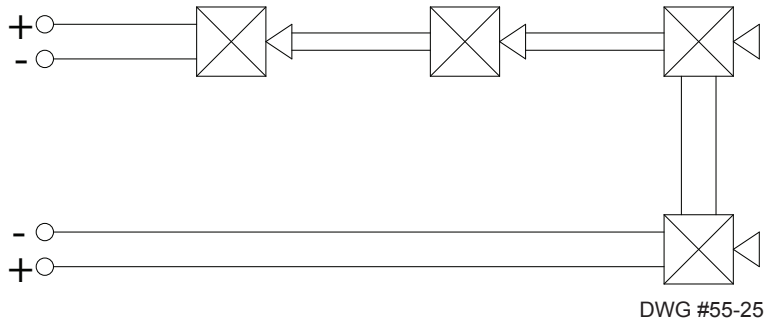
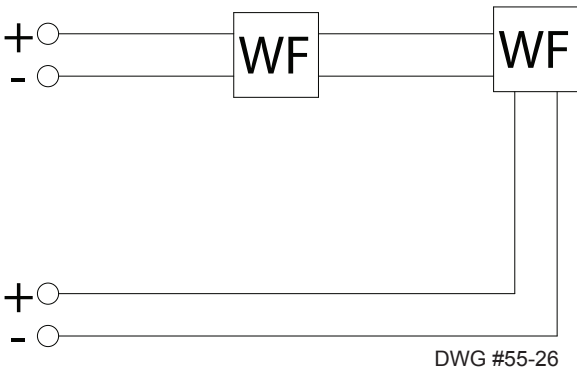

Figure 10. Class A IDC Wiring Example on Conventional Panels



End of Line Resistor Supervision

End of line resistors (EOLR) play an important role in maintaining a panel's reliability in several ways. A small amount of electrical current is sent (from the control panel) out through the initiating device circuit and through the EOLRs. Next, the panel measures the amount of current being returned, and then responds accordingly:

- If the current is in the normal or midrange, the panel is "normal."
- If the panel detects too little or no current, this usually indicates an "open" circuit. The panel indicates a "trouble" condition when this occurs.
- If the panel sees too high of a current, the panel interprets it as a short, and indicates an "alarm" condition.

Example: When a pull station or heat detector (*i.e., dry contact device*) is activated, they cause a direct short on the initiating circuit. This initiates an "alarm" condition on the panel.

Another way EOLRs maintain a panel's reliability is that they can be used to **monitor** notification appliance circuits (NACs) and devices. They are also monitored for ground faults or a high amount of resistance to ground potential.

Initiating Device Circuits (IDCs)

Initiating Device Circuits (**IDCs**) connect automatic (*i.e., smoke detectors, heat detectors, etc.*) or manual initiating devices (*i.e., pull stations*). These devices are connected directly to a "zone" on a conventional fire alarm control panel or to a monitoring input module on an addressable fire alarm control panel. The signal received at the fire alarm control panel does not identify the individual device that is in an "off normal" condition. Rather, the entire circuit is considered "off normal." ("Off normal" conditions include alarm, supervisory and trouble.)

When these circuits are wired as Class B they use an EOLR (End of Line Resistor) to monitor the integrity of the wire. When wired as Class A on a conventional panel, the integrity of the circuits are monitored by the fire alarm control panel zone; whereas on an addressable panel, they're monitored by a dual input monitoring module.

Figure 11. Class B EOLR Wiring Example

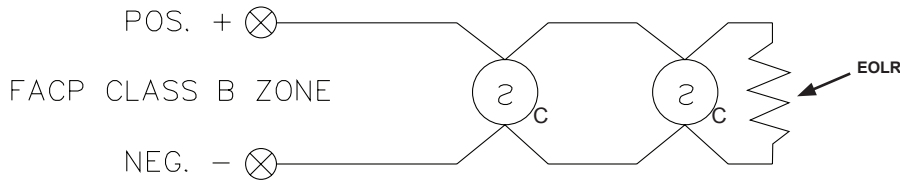

DWG. #55-2

DEVICE LEGEND	
	ADDRESSABLE SMOKE DETECTOR
	CONVENTIONAL SMOKE DETECTOR
	ADDRESSABLE PULL STATION
	WATERFLOW SWITCH
	ADDRESSABLE MONITOR MODULE
	HORN/STROBE
	END OF LINE RESISTOR

Figure 12. Class B IDC Wiring Examples Shown on Conventional & Addressable Panels

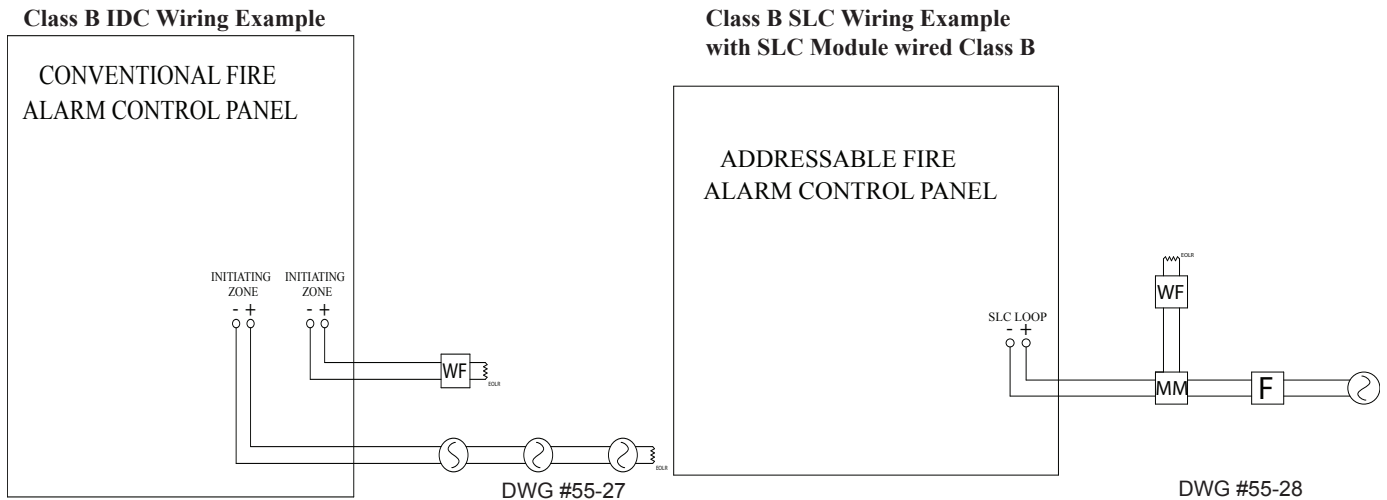

DWG #55-27

DWG #55-28

Class B IDC Wiring Notes:

- On the conventional panel, the WF (water flow) and smoke detectors are supervised by separate EOLRs. Each zone on a conventional panel is an IDC.
- On the addressable panel, the SLC loop supervises the MM (addressable monitor module), smoke detector and pull station.
- The MM supervises the WF (water flow) device. The wiring between the monitor module and waterflow switch is an IDC circuit. An EOLR is placed at the last WF device for IDC circuit supervision.

Figure 13. Class A IDC Wiring Examples Shown on Conventional & Addressable Panels

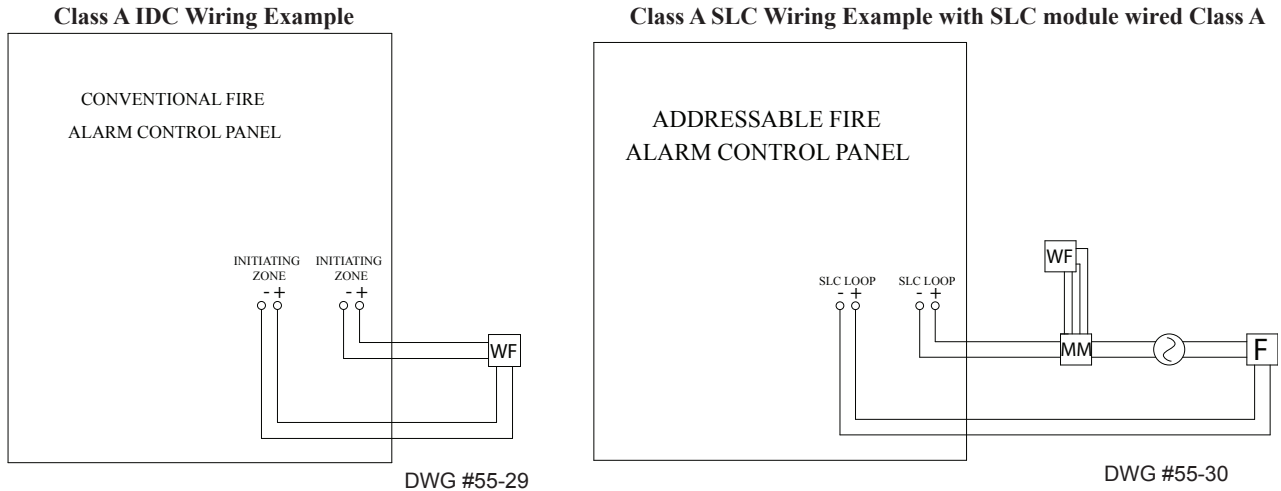

Class A IDC Wiring Notes:

- For Class A IDC wiring on a conventional panel, the circuit starts at the panel and returns to the panel. In most cases, this type of wiring requires two (2) initiating zones. No EOLR is required in this style of wiring.
- For Class A IDC wiring on an addressable panel, the MM device provides the return terminals for monitoring the WF device. No EOLR is required in this style of wiring.

Notification Appliance Circuits (NACs)

NAC circuits are monitored by EOLRs or Class A wiring.

Note: Refer to *NFPA 72 2013 18.3.6-A.18-3.6* for more information on these topics.

Figure 14. Class B NAC Wiring Diagram

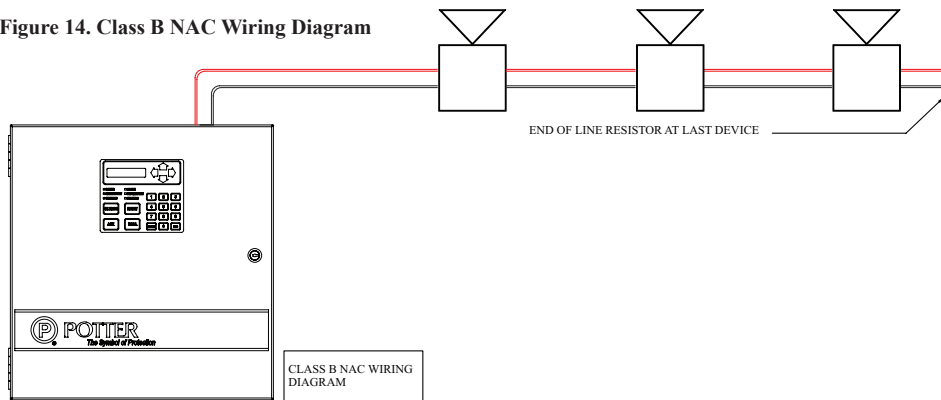

Class B NAC Wiring Notes:

- Each NAC circuit has its own End of Line Resistor, operational capacity stops at a single open.
- Conditions that affect the intended operation of the path are annunciated as a trouble signal.

Figure 15. Class A NAC Wiring Diagram

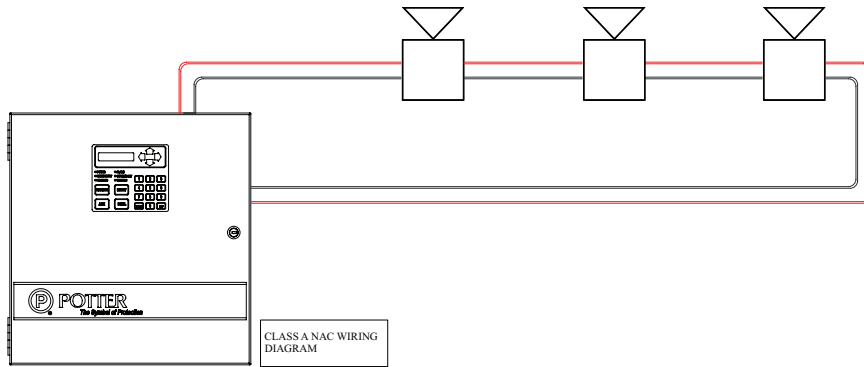

Class A NAC Wiring Notes:

- NAC circuits do not require an End of Line Resistor, a redundant path is included. Operational capability continues beyond a single open.

Signaling Line Circuit Overview

On Potter Electric's addressable panels, SLCs provide power and communication to each sensor and module. Every 4–5 seconds, each device on the SLC is polled by the system to check that it's communicating with the control panel. When this occurs, the device's LED blinks. However, before a device is connected to the control panel, it must have an address, as shown in the example below.

Figure 16. Example of SLC with Addressed Devices

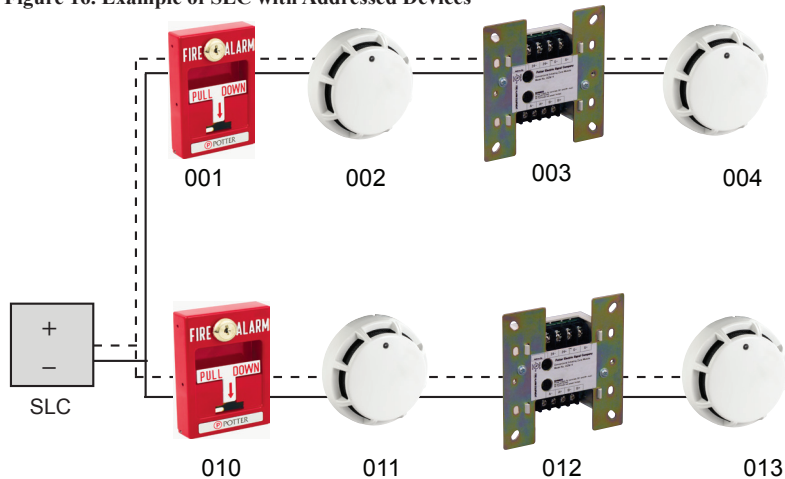

The total number of sensors, and modules (or points) varies between manufacturer's panels. For example, Potter Electric's IPA-100 fire panel provides 127 addressable points, and the IPA-4000 supports up to 4064 points. The devices can be configured in any combination of sensors and modules.

Figure 17. Example of Potter's IPA Series – Class B SLC Terminal Connections

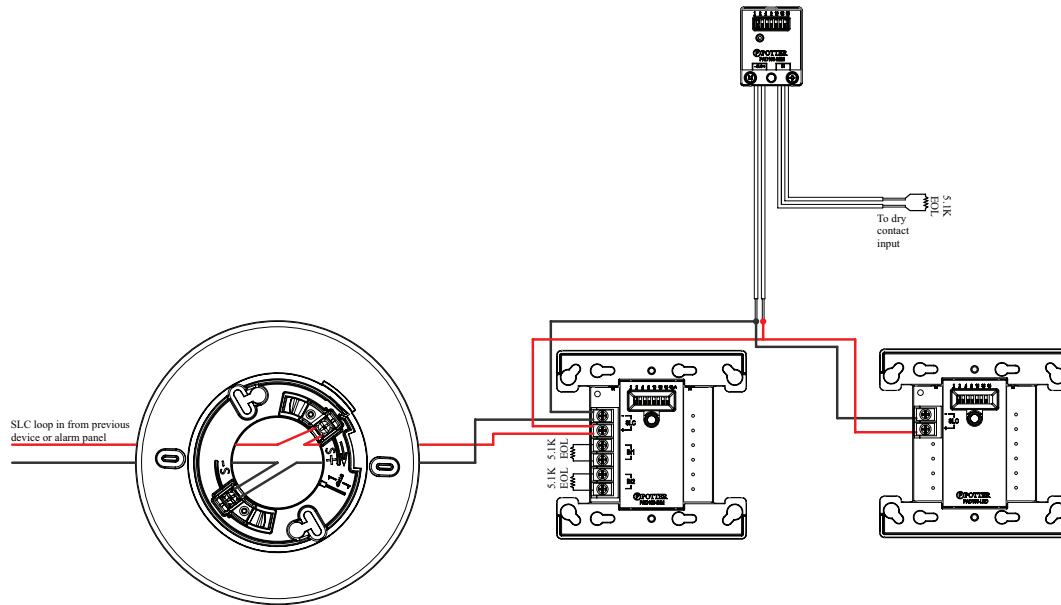
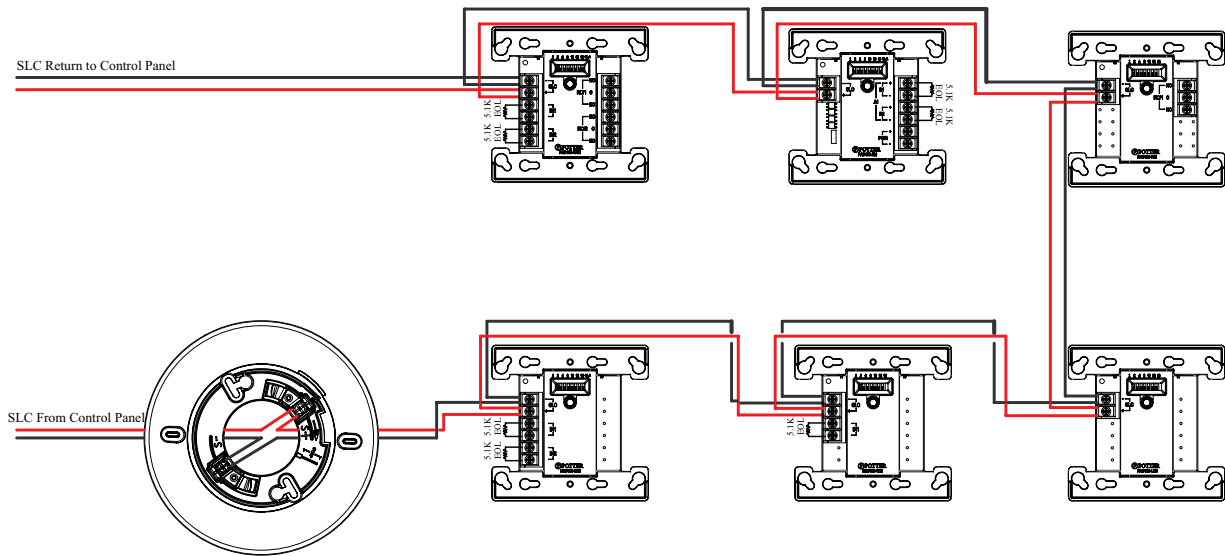

Figure 18. Example of Potter's IPA Series – Class A SLC Terminal Connections



T-Tapping/Branch Circuits

A T-tap is a parallel circuit off of the SLC loop. It is not allowed on conventional fire alarm systems. There is no limit to the number of "T-Taps", however Potter limits the SLC to a maximum of 50 Ohms of resistance and 0.5 micro farads of loop capacitance.

NOTES:

1. NACs and IDC should never be T-tapped to allow for correct supervision.
2. Class A SLCs **cannot** be T-tapped. If a single fault occurs on the T-tapped portion, **all** devices are **disabled** on that section.
3. T-tapping **cannot** be used on a conventional fire panel.

Figure 19. Examples of T-Tapping on Addressable Circuits

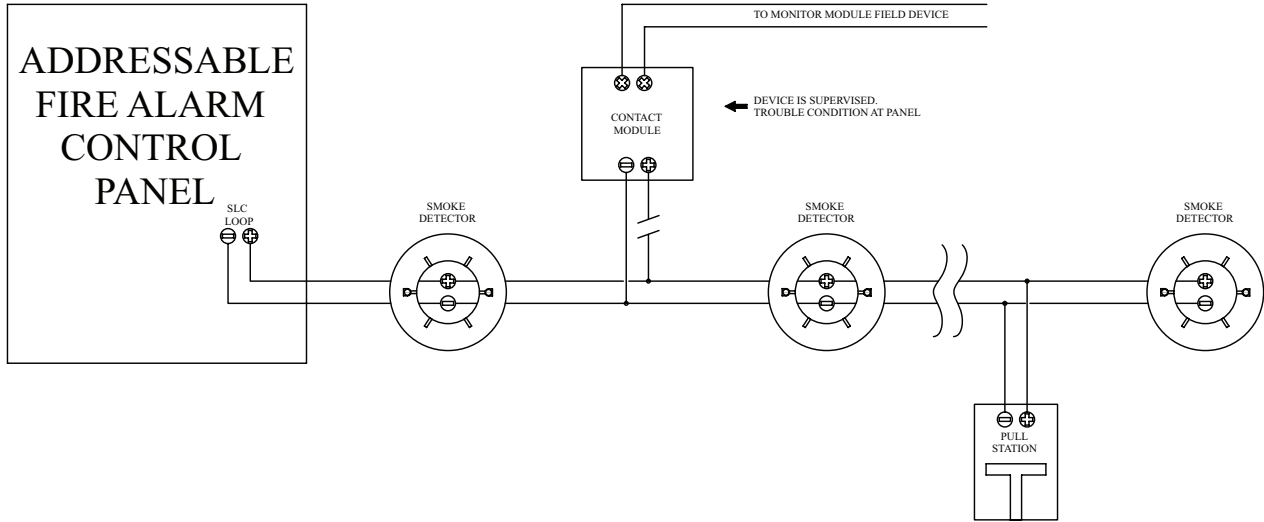

Isolator Devices

Class X wiring requires a PAD100-IB (Isolator Base) to be installed for each sensor and/or PAD100-IM (Isolator Module) to be installed on each side of each module.

Figure 20. Example of Potter PAD Protocol Class X Showing PAD100-IMs installed

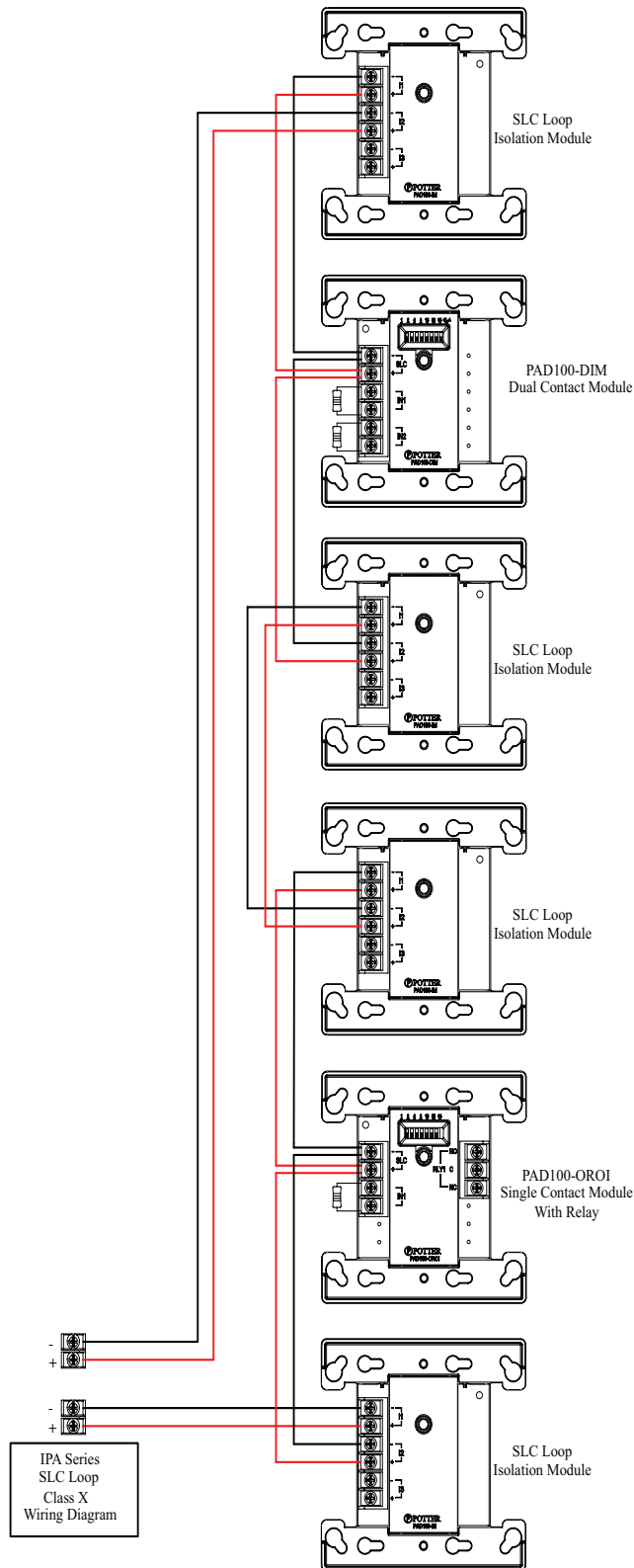

RS-485 Connections

Fire systems may provide a RS-485 connection that supports system accessories. For example, Potter Electric's P-Link (RS-485) bus supports a variety of system accessories, including remote annunciators, SLC Expanders and addressable NAC Power supplies. These accessories directly connect to Potter's IPA series control panels via a four-wire P-Link bus for power and communication. Wiring supports both Class A and Class B styles and an example of each are shown below:

Figure 21. Examples of Potter's P-Link Class B Wiring & Class A Shown with a CA-6075 Expander Connection

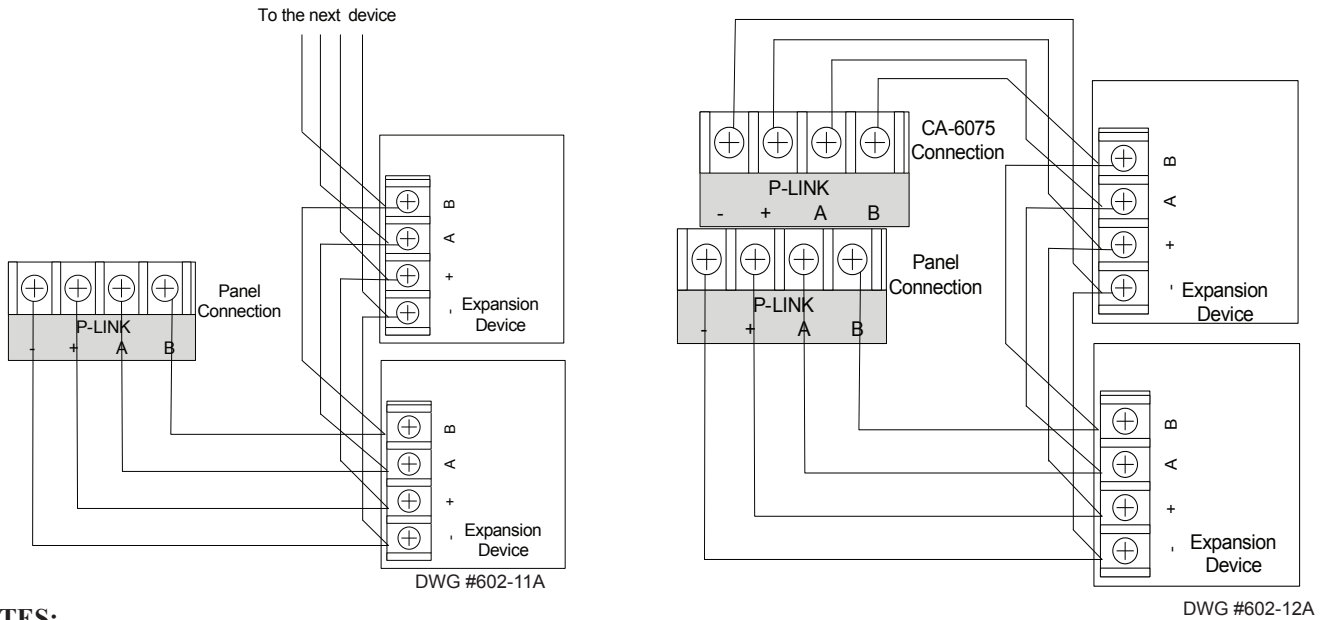

NOTES:

1. Potter's smaller panels support a minimum of 64 P-Link devices and their larger panels support 128 P-Link devices
2. Maximum wire length for all P-Link devices and accessories is 6500 Ft when 14 AWG is used.

Section 4: Initiating Device Requirements

This section provides an overview of initiating devices, which includes smoke and heat detectors, manual pull stations, air duct detectors and addressable modules. Most importantly, this section addresses how and where to correctly install these devices based on many different factors.

For example, a building's size and occupancy classification greatly impacts installation requirements. Other factors, such as the location of air diffusers and whether the facility is new construction or an existing building, also effects the installation of devices. The system designer must take these factors into account, as well as follow all applicable codes to ensure that the fire alarm system meets the fire safety protection requirements at each facility.

Note: Refer to *NFPA 72 2013, Section 17* for more information on these topics.

Initiating Device Overview

All **initiating devices** on an addressable fire alarm system operate by sending a signal to the fire alarm control panel when they are in an alarm (or "off-normal") condition. The fire alarm control panel then activates the appropriate output devices. For example, when a pull station is activated, the building notification may turn on.

Figure 22. Examples of Potter's Manual Single & Dual Pull Stations PAD100-PSSA/PAD-100 PSDA & Pull Station Series



Figure 23. Examples of Potter's Smoke Detector (PAD100-PD), Smoke Det/Heat Det (PAD100-PHD), Rate of Rise/Fixed Temperature Heat Detector (PAD100-HD) & Duct Smoke Detector (PAD100-DUCT/PAD100-DUCTR)



Installation Overview

Installation requirements vary based on the type of initiating device being installed. Another factor is the type of facility, such as commercial vs. residential, and new vs. existing construction.

Note: Refer to *NFPA 72 2013, 17.6.3, 17.6.4.2, 17.7.4-17.7, and Appendix B.4.10* for more information on these topics.

Manual Alarm Station Types

At least one manual pull station is required when either a fire alarm or monitored sprinkler system is installed. The system designer chooses the appropriate type needed at each facility based on the level of protection they determine is needed to prevent accidental operation.

Pull station types are:

- Single Action
- Dual Action
- Break Glass Stations
- Key Operated

Single Action pull station models are typically used in most applications. They are activated with a **single pull down action**, which can be a disadvantage since they can be easily activated.

The **Dual Action model** requires **two actions to activate**, usually a push then pull or a lift and pull. These types are less susceptible to accidental activation. Most pull station models are available in both single pull down and dual action models, such as Potter Electric's Addressable Single & Dual Action Pull Stations (APS-SA/APS-DA).

Key Operated model requires a Key to activate or deactivate an alarm. Mostly used in Institution or Correctional applications.

Figure 24. Examples of Potter's Addressable Single & Dual Action Pull Stations (PAD100-PSSA/PAD100-PSDA)



Manual Alarm Station Installation Requirements

The placement of pull stations is specified by the AHJ and building code. They determine the exact requirements for the location of pull stations, as well as enforce that the device is UL listed for the specified area.

Notes:

1. Pull stations installed outdoors or in wet environments, must be tested and listed for that application. Special hazard manual stations are manufactured for intrinsically safe environments.
2. If applicable, pull stations must be designed and installed to meet the American's with Disabilities Act.
3. Some specialized applications require specific devices designed for an exact function, such as emergency notification, egress stations in access control systems, or nurse calls. These applications cannot use a standard fire alarm pull station.

The NFPA's requirements include:

- The operable part of the pull station must be mounted between **3.5 – 4.0 feet** from the floor according to NFPA 72 2013.
- The device must be securely mounted to prevent damage and false activation.
- The pull station must be obviously located and contrasted so they are easy to locate (*i.e., in the United States they must be "red" and marked with the word "FIRE"*).
- Pull stations should be located **within 5 feet** of each egress on each floor.
- There should **not** be more than **200 feet of travel distance** between pull stations if multiple pull stations are required throughout a building.

Smoke Detectors

When choosing the type(s) of smoke detector(s) to install, the building's environmental conditions should be heavily considered. Some types are highly effective in a limited, specified range (*i.e., typically less than 900 sq. feet*), and others for wide open, larger areas up to 19,800 sq. feet. Those that cover limited areas are referred to as "spot" detectors.

Smoke Detector Types

Ionization smoke detectors are the most basic type of smoke detector used, but also the most likely to produce a false alarm. Dual-chamber ionization detectors help to stabilize the operation of the detector; however, altitudes greater than 3,000 feet can adversely affect the detector's performance.

Photoelectric smoke detectors are more reliable than ionization detectors because of their technology. There are 2 types of *Photoelectric smoke detectors*: *light scattering and light obscuration*.

- Light scattering is the most commonly used spot detector. An alarm occurs when the detector senses or "sees" the light source due to the reflection caused by smoke. These detectors have a range of sensitivity settings which puts it into an alarm condition when sufficient light is scattered or refracted into the sensor. (*Refer to Potter's PAD100-PD and PAD100-PHD examples below.*)
- Light obscuration detectors are used in larger, open spaces greater than 900 sq. feet. Beam smoke detectors are commonly used when this type is installed in a facility. These detectors are designed to transmit a beam of light to a receiver, and if the light is not seen by the receiver, the detector goes into alarm. (*Refer to the OSID beam smoke detector example below.*)

The *photoelectric smoke / heat detector* is a variation of the photoelectric detector. This design is a combination smoke / heat detector, which can detect the existence of smoke molecules and also measure thermal energy produced by heat. Please refer to the "*Heat Detector's*" heading to learn more about these types of detectors.

Examples of Potter's photoelectric smoke (PAD100-PD), smoke/heat combination (PAD100-PHD) addressable detectors, and the OSID beam smoke detector available through Potter are shown below:

Figure 25. Examples of Potter's Smoke Detector (PAD100-PD) & Smoke Det/Heat Det (PAD100-PHD) & OSID Beam Smoke Detector



Smoke Detector Installation Considerations

A building's ceiling type is an important factor in planning smoke detector installation. If a facility's ceiling is flat and has smooth surfaces, the following installation requirements must be followed:

- Smoke detectors typically are **installed every 30 feet**, unless a specific performance-based design requirement is identified.

Note: Refer to the manufacturer's published instructions to ensure that the device is installed correctly.

Figure 26. Diagram of Acceptable Rectangle Dimensions for Smooth & Flat Ceilings

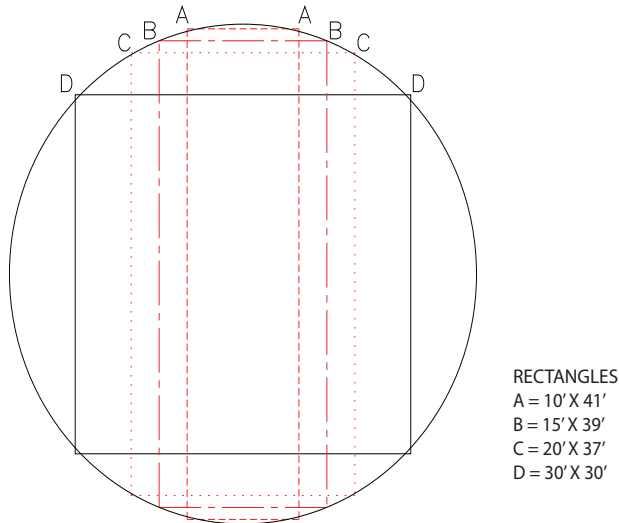

DWG #55-3

Diagram Notes:

1. If 30 feet is used as a guide, any square that fits inside of a circle with a 21 foot radius could be covered with a single smoke detector.
 2. A 10ft. by 41ft. area can be covered by one smoke detector using 30ft. spacing.
- Spot type smoke detectors must be **located on the ceiling** or, if on a **sidewall between the ceiling and 12" down** from the ceiling to the top of the detector.
- Note:** Detectors must never be mounted more than 12" below ceiling level.
- The distance between detectors must not exceed their selected spacing. There must be detectors within one-half the selected spacing, measured at right angles, from any side wall.
 - Detectors must not be recessed mounted unless it's specifically listed for recessed mounting.
 - Detectors must be supported independently of their attachment to circuit conductors.

Smoke Detector Installation Considerations continued...

- When smoke detectors are installed near heating, ventilation and air conditioning units or fluorescent lights, several important guidelines must be followed:
 1. Detectors must be a minimum 36" (or 3 feet) from air diffusers **plus** they should not be located anywhere that the airflow exceeds the listed limitations for the detector.
 2. Detectors are effected by humidity, ambient temperature and the velocity of air around it.
 3. If detectors are installed too close to air supply diffusers, the air flow emitted from the diffuser can prevent smoke from reaching the detector. Detectors installed too close to an air return can prevent the detector from activating due to the effect of diluting smoke concentrations near the air return grille.

Figure 27. Example of Installation Requirements for Smoke / Heat Detectors & Manual Pull Stations

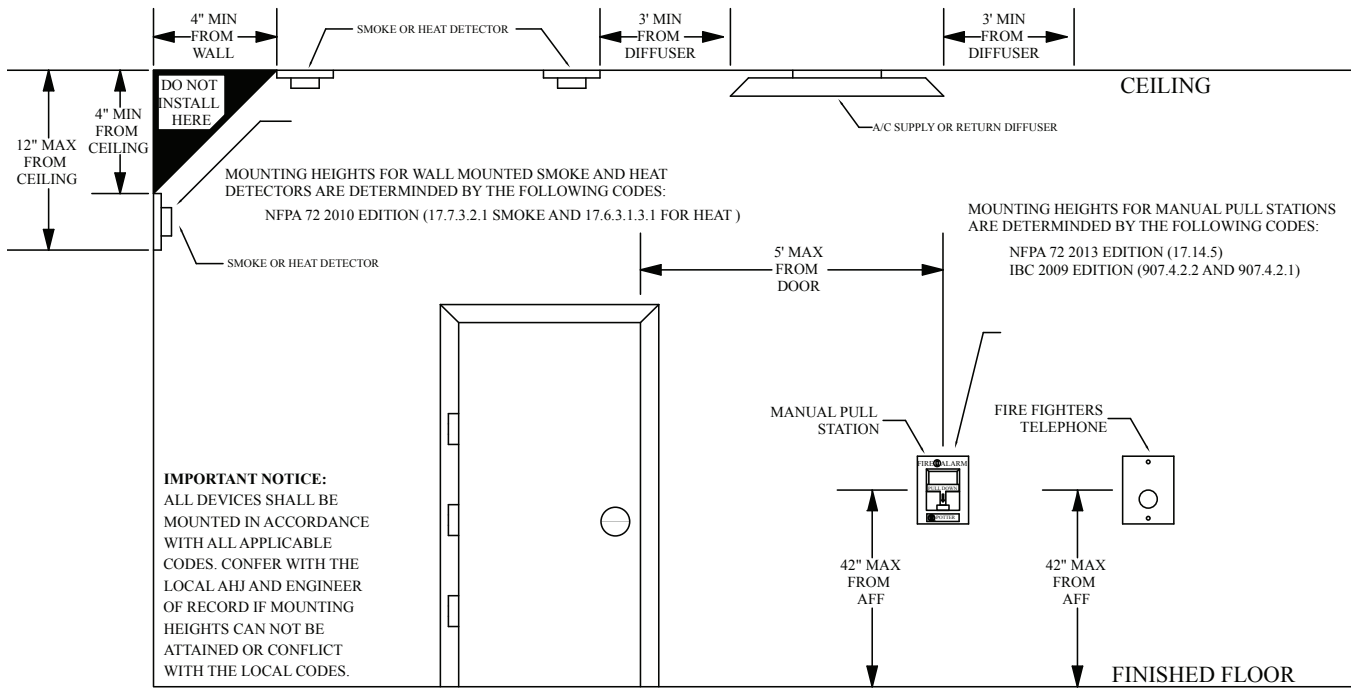

DWG #55-29

Smoke Detectors in Residential Occupancies

Smoke detectors are required in all residential occupancies. Since over 80% of all fire deaths occur in residential occupancies, all residential occupancies need a minimum of a single station smoke detector on each floor of the building.

Notes:

1. Please refer to *NFPA 72 2013, Sections 3.3.269–3.3.269.5, 17.5, 17.7, and 29.5-29.6.2; NFPA 72 2010, Section 29.8.3* for more information on these topics.
2. Most smoke devices are battery operated; however, it is strongly recommended that they are powered from line voltage and have a battery back up. This provides greater protection because it doesn't rely on the homeowner's intervention.

Residential Smoke Detector Types

A majority of the smoke detectors installed in residential occupancies use the *ionization chamber method* of smoke detection. However, some states and local jurisdictions have adopted codes that require either a *photoelectric smoke detector* or *dual technology device* that use both a photoelectric and ionization principle smoke detection. The *ionization method* of smoke detection has been found to have inadequate or unacceptable response times in some cases.

Residential Smoke Detector Location

It's important to consider the location smoke detectors are installed in a residence to prevent or reduce the number of false or nuisance alarms. For example:

- Smoke detectors in kitchens detect cooking by-products (*i.e., grease*) which may cause alarms to activate.
- Steam from bathrooms set off detectors in hallways.
- Smoke detectors installed in areas where the temperature is too low or too high will not operate correctly, *i.e., garages, kitchens, bathrooms*.

New Residential Installation Considerations

In new construction, smoke detectors are required on all levels of the home, in each bedroom and within ten feet of each bedroom door. Other requirements include:

- High ceilings (*i.e., vaulted and cathedral type*) with a slope greater than 1 foot in 8 feet must have a detector installed in the high side of the room but not closer than 4 inches from the adjoining wall.
- Garages, crawl spaces and unfinished attics are exempt from smoke detector requirements due to the high probability of false alarms. The detectors are not listed to operate in these types of environments.
- Smoke detectors installed in basements should be installed in close proximity to the stairs because smoke has a tendency to travel upward.
- Smoke detectors are required to have primary power from line voltage and a battery back up.

Note: Batteries must be changed twice a year.

- Smoke detectors are required to be interconnected so that when one sounds, all devices sound.

The example below shows smoke detectors installed in a new residence.

Figure 28. Example of Smoke Detectors Installed in a New Residence

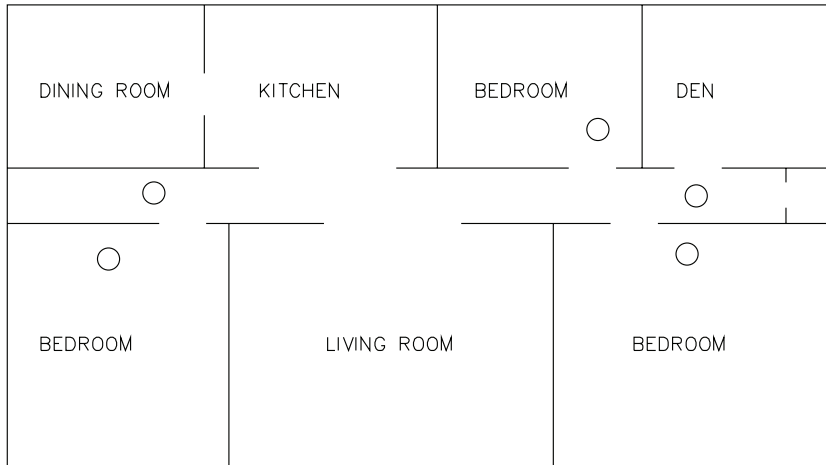

DWG. #55-6

○ = SMOKE DETECTOR LOCATION

Existing Residential Installation Considerations

Smoke detectors should be installed outside of the bedrooms in the immediate vicinity of the bedrooms in existing homes. However, if all bedrooms are located in one area, one detector is allowed. Refer to the example shown below:

Figure 29. Example of Smoke Detector Installation in Existing Home with Bedrooms in Same Vicinity

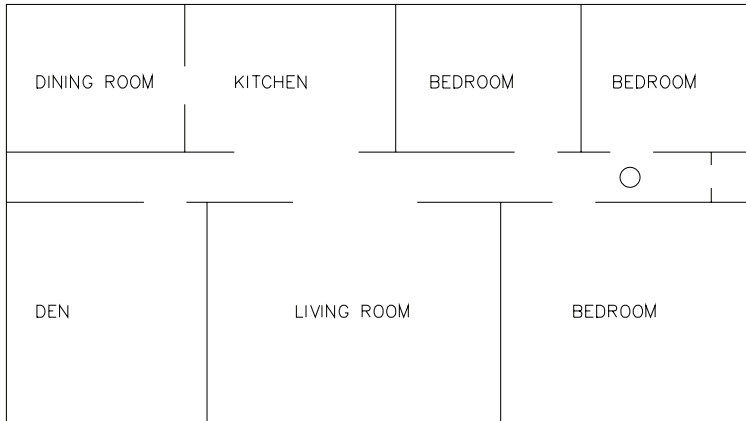

DWG. #55-8

○ = SMOKE DETECTOR LOCATION

In the next example, the bedrooms are separated, so multiple detectors are required. Also, if the house has several floors, at least one detector must be installed per floor.

Figure 30. Example of Smoke Detector Installation in Existing Home with Separated Bedrooms

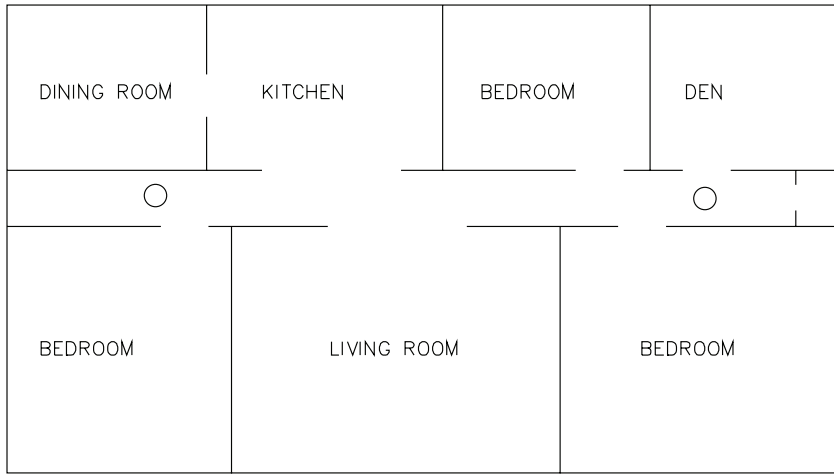

DWG. #55-7

○ = SMOKE DETECTOR LOCATION

In contrast, the following example shows the number of detectors and configuration for a new home. The bedrooms are in the same area, but each bedroom must have a smoke detector, plus another one for the immediate vicinity.

Figure 31. New Construction Smoke Detector Installation Showing Bedrooms in Same Vicinity

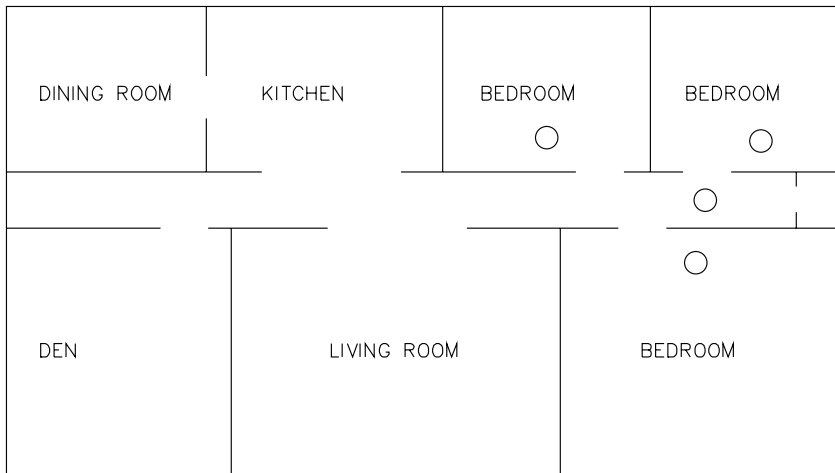

DWG. #55-9

○ = SMOKE DETECTOR LOCATION

Air Duct Smoke Detectors

Duct detectors are used primarily to sense smoke in the HVAC system to enable AHU (*Air Handling Unit*) shutdown to prevent distributing smoke throughout a facility. In some instances, duct detectors are also used to control fire/smoke dampers. An example of Potter's analog addressable duct detector (PAD100-DUCT) is shown below:

Figure 32. Example of Potter's Analog Addressable Duct Detector (PAD100-DUCT)

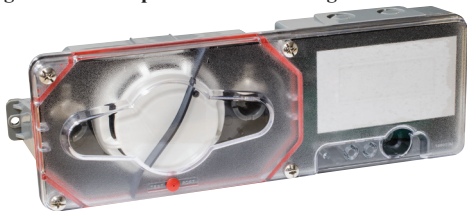

Note: Refer to *NFPA 72 2013, Sections 17.7.5.5 — 17.7.5.5.7* for additional information on this topic.

Duct Detector Requirements

There are various conditions that dictate when duct detectors are required on AHUs and when they're required to control dampers. NFPA 101, NFPA 90A, IBC, and IMC all have sections on duct detector requirements. Contact your AHJ to determine which code they follow for the particular project. Generally, duct detector requirement guidelines are as follows:

- **AHU (Air Handling Unit) requirements** — NFPA 90A is commonly referenced, and it states that one duct detector must be installed on the supply side of the AHU if that AHU is over 2,000 CFM. If the unit is more than 15,000 CFM, it also requires that a duct detector is installed on the return side of the AHU.
- **Fire/smoke damper requirements** — Refer to the particular project to determine which code should be followed. Commonly, when fire/smoke dampers are installed in a duct, a duct detector should be installed within 5 feet of the damper. Dampers should be closed when the AHU is shutdown. For other damper placements, spot-type detectors are usually required to control the damper.

There are many factors that play into damper control and AHU shutdown. Always consult all applicable Code and the AHJ for each specific project to ensure that the facility's occupants are protected from a fire within the HVAC unit or near the fresh air intake for the unit.

Air Duct Detector Installation Considerations

When duct smoke detectors are installed externally, a sampling tube is used to sample the duct's airflow. As shown in the diagram below, the tube should be mounted vertically to improve detector performance. Additionally, the sampling tube should be supported or installed away from the detector if the duct is larger than 3 feet.

Figure 33. Example of an Installed Duct Air Detector Showing Air Sampling Tube

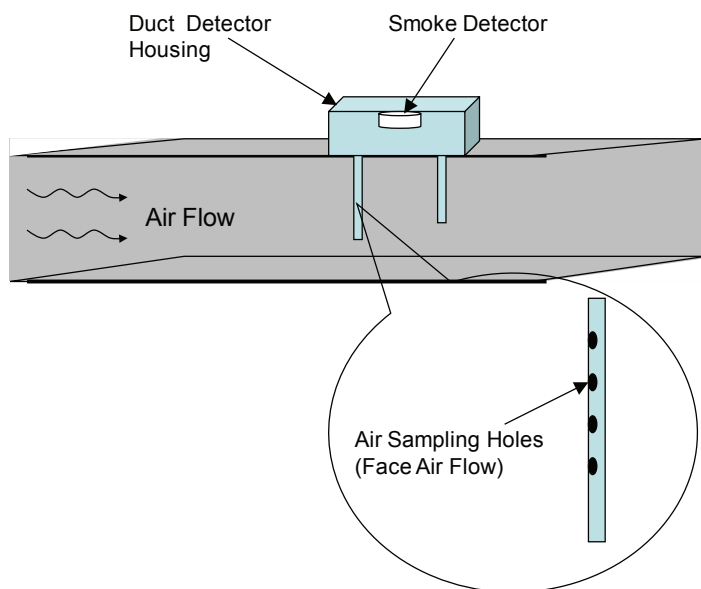

Other duct detector installation factors are:

1. The detector should be mounted away from any bends or obstructions in the duct, and 6 or more duct widths from the return inlet.
2. If duct detectors are installed more than 10 feet above the floor and the detector's alarm and supervisory indicators are not visible, the AHJ requires that remote alarm and supervisory indicators are installed in a specific location. A label must be shown on the remote indicators that describes their function and the associated air handler. However, if the air handler individually annunciates at the fire alarm control, then remote indicators are not required.

Heat Detectors

Heat detectors are used to detect thermal energy produced by a fire. Although they are the cheapest type of automatic detector to install, they are the slowest to respond due to "*thermal lag*." This is the time it takes the detector to respond physically to the air temperature at the detector (*i.e., melting or expanding*).

There are many types of heat detectors, including photoelectric, thermopile, thermistor, rate compensation, and pneumatic line. Each type's technology varies greatly in order to address a wide range of environmental factors. A few of these detector types are addressed in this section.

Note: Please refer to *NFPA 72, 2013, Section 17.6*, for more information on this topic.

Heat Detector Types

The two most commonly used heat detectors are *fixed heat and rate of rise/fixed temperature detectors*. They're referred to as "*spot*" detectors, like smoke detectors, because their detection element is concentrated in a single location. Fixed heat and rate of rise/fixed detectors are designed to go into alarm when the temperature at the detector reaches a set-point or specific temperature. They have an adjustable range of temperatures to allow for a range of ambient environmental temperatures.

Example: *Potter's PAD100-HD fixed heat detector* set point may be set between 135°- 185° Fahrenheit.

Figure 34. Example of Potter's Addressable and Conventional Heat Detectors



The main difference between these two detectors is that the *rate of rise/fixed heat temperature detector* provides earlier heat detection than a fixed heat detector because it detects when the air temperature increases a specified amount within a period of time (*i.e., typically greater than 15° Fahrenheit per minute*).

Line type pneumatic heat detectors may be used in environments that produce a sudden rise in temperature. A metallic tubing runs through the protected area. The looped tubing contains air which presses against a diaphragm when the increased air temperature is sustained. The diaphragm triggers the circuit to close, which produces an alarm.

Heat Detector Installation Considerations

When installing heat detectors, the following guidelines must be followed:

1. Heat detectors are **not** considered life safety equipment; they are for property protection only.
2. Heat detectors should be installed where conditions are **not** favorable for smoke detectors, such as kitchens, garages, attics, boiler rooms, etc.
3. If a **ceiling's height** is greater than 9 feet 11 inches (*i.e., or is between 10 feet to 30 feet*), the heat detector **spacing must** be reduced as follows:

Table 6: Spacing Rules when Installing Heat Detectors in Buildings with 10-30 Feet Ceiling Height		
Above (Shown in Feet)	Up To (Shown in Feet)	Percent of Listed Spacing
0	10	100%
10	12	91%
12	14	84%
14	16	77%
16	18	71%
18	20	64%
20	22	58%
22	24	52%
24	26	46%
26	28	40%
28	30	34%

4. The maximum ceiling temperature in the area where the heat detector is installed **must** be **20 degrees or more below the operating temperature** of the heat detector.
5. If a **building's temperature** is a factor in selecting the correct type of heat detectors, refer to the following NFPA 72 table:

Table 7: NFPA 72 Heat Detector Selection Guide			
Temp Classification	Temp Rating Range °F	Max Ceiling Temp °F	Color Code
Low*	100 – 134	20 Below**	Uncolored
Ordinary	135 – 174	100	Uncolored
Intermediate	175 – 249	150	White
High	250 – 324	225	Blue
Extra High	325 – 399	300	Red
Very Extra High	400 – 499	375	Green
Ultra High	500 – 575	475	Orange

* Intended only for installation in controlled areas. Units **must** be marked to indicate maximum ambient installation temperature.

** Maximum ceiling temperature **must** be 20 degrees Fahrenheit or more below the detector rated temperature.

Note: The difference between the detector's rated temperature and the maximum ambient ceiling temperature should be as small as possible to minimize response time.

Fire Sprinkler Panels

When the occupancy class of a building requires fire sprinklers, they may supervise one or more of the following devices and appliances:

- Water Supply Control Valves
- Alarm Line Supervision
- Fire Pump Status
- Water Tank, Levels and Temperature
- Low and High Air Pressure on Dry Pipe Systems

Note: Refer to *NFPA 72 2013, 17.12–17.16.5* for more information on these topics.

Below is an example of Potter Electric's Sprinkler Monitoring Panel, and several waterflow / control valve supervisory switches.

Figure 35. Potter's PFC-6006 Sprinkler Monitoring Panel



Figure 36. Potter's OSYSU Outside Screw and Yoke Valve & PCVS Control Valve Supervisory Switch



Figure 37. Potter's VSR Waterflow Alarm Switch and VSR-S Vane Waterflow Switch

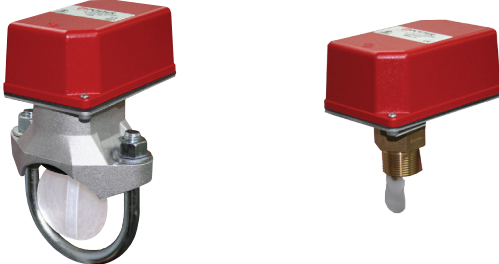

Section 5: Notification Appliances Requirements

This section tackles building codes, AHJ or other governing codes or standards notification equipment requirements. Because each building's occupancy is unique, different types of notification equipment, such as *horns, strobes, bells, and remote annunciators*, may or may not be required. The system designer must consider the building's occupancy classification(s) along with other factors, including the ambient sound and temperature levels, and type of facility (*public vs. private*), when selecting the notification equipment.

Note: Refer to *NFPA 72 2013 Section 18* for more information on these topics.

When notification devices are required, they must be installed according to NFPA 72's applicable rules and guidelines.

This section addresses the following topics:

- Types of Audible Signal & Visual Notification devices
- Audible Signal building code requirements
- Visual Notification building code requirements
- Measuring light output and candela requirements
- Measuring audible sound pressure (dB) requirements
- Average ambient sound level considerations
- Special requirements for corridor installations
- Types of Remote Annunciators
- Fire Alarm Signal Classifications

Notification Appliances Overview

Notification equipment or appliances consist of a wide variety of devices, such as: *fire alarm horns, bells, and strobes and possibly voice evacuation speakers, alarm printers, remote annunciators, textual and graphic displays.*

Note: Always refer to building codes, AHJs, NFPA standards, and insurance providers (or certifying entities) to determine the specific requirements.

Most facilities require that both **audible** and **visual alarm signaling** be installed. For example, large commercial complexes may require audible devices, such as *bells, chimes and horns*, and also *flashing strobe lights or rotating beacons* (visual devices). Some manufacturers have devices that produce both audio and visual signaling, such as Potter Electric's SASH Sprinkler Alarm Select-A-Strobe/Horn/Sign combination, the S-24 selectable strobe & horn/strobes, and HS-24 are shown below.

Figure 38. Example of Potter's Sprinkler Select-A-Strobe/Horn/Sign Device & S-24 Selectable Strobe



Figure 39. Example of Potter's PBA-AC & MBA-DC Bells



Audible Notification Requirements

An audible notification device is any notification appliance that alerts occupants by the sense of hearing. These devices include: *horns, bells, sirens, voice evacuation, and speakers*. All audible notification devices must be loud enough to be heard in order to alert building occupants. Each device is UL tested to determine if it meets the minimum **sound pressure** guidelines as set by the NFPA. The sound pressure level of a device is expressed as a **decibel or dBA level**.

Note: Please refer to *NFPA 72 2013 Section 18.4-18.4.5.3, A.18.4.3-18.4.4 and 18.5.5* for more information on this topic.

Another requirement is that audible devices must be able to produce **distinctive signals** that are different from other devices that aren't part of the fire alarm system. The NFPA 72 standard signal pattern is a **three-pulse temporal sound**, which alerts building occupants to evacuate the building. For example, Potter Electric's MHT-1224 Mini Horn series and FASPKR-24CLP Low Profile Speaker series are shown below.

Figure 40. Example of Potter's MHT-1224 Series & FASPKR/SPKSTR-24CLP Low Profile Speaker/Strobe



- *Voice Evacuation systems* may be required for large complexes or multi-level buildings, such as movie theaters, auditoriums and churches. Mass voice paging may be used during an emergency to provide the necessary fire protection level at these types of installations.

Average Ambient Sound Level Guidelines

The **average ambient sound levels** of an occupancy impacts the specific type of audible devices that should be installed. The term "*ambient*" refers to the sound levels that are in the immediate or surrounding area. In some occupancies, such as urgent care areas in hospitals or noisy industrial complexes, audible devices may be ineffective or inappropriate. For example, if a building has average ambient sound level **greater than 105 dB** (i.e., *such as a night club*), the building **must** have **visible notification**.

Example: *Potter Electric's PVX-150 and PVX-200 Voice Evacuation systems* provide a digitally recorded automatic evacuation message, a bullet-proof amplifier, a live microphone override feature of the digital message, and many other versatile options.

Figure 41. Example of Potter's PVX-150 & PVX-200 Voice Evacuation Systems



Each occupancy should be evaluated to determine the correct audible devices to be installed. The table below shows **average ambient sound level** requirements for a wide variety of occupancies.

Table 8: Average Ambient Sound Level Requirement Guidelines	
Location	Average Sound Level in dBA
Business Occupancies	55
Educational Occupancies	45
Industrial Occupancies	80
Institutional Occupancies	50
Mercantile Occupancies	40
Mechanical Rooms	85
Piers and Water Surrounded Structures	40
Places of Assembly	55
Residential Occupancies	35
Storage Occupancies	30
Thoroughfares, high density urban	70
Thoroughfares, medium density urban	55
Thoroughfares, rural and suburban	40
Tower Occupancies	35
Underground Structures and Windowless	40
Vehicles and Vessels	50

Multiple Rated Audio Devices

These devices are capable of producing a range of output audio/visual settings, which allow them to be used for dual functions, such as life safety / protection, and burglar alarm systems. *For example, Potter Electric's SH-120 Select-A-Strobe, shown below, has six selectable audio settings: 81.1-87.8 dBA.*

Figure 42. Potter's Select-A-Strobe/Horn Wall Mount Weather Proof (SH-120 series)



Low-Frequency Sounder Requirements

The requirement to provide low frequency alarm signaling in sleeping areas was first introduced in NFPA 72, 2010 Edition with an effective date of January 1, 2014. The tone used for low frequency signaling devices is a 520 Hz square wave. This tone was selected after a research study determined that 520 Hz was much more effective at waking people with hearing loss and alcohol-impaired individuals.

Please refer to *NFPA 72, 2013 18.4.5* for more information.

Figure 43. Potter's LFH Low Frequency Horn and LFHS Low Frequency Horn Strobe



Other Audible Device Installation Considerations

In addition to the average ambient sound-level requirements, there are many other factors that impact the installation of notification devices, such as:

- Audible devices are typically mounted on walls, however, most devices are also listed for ceilings.
- Audible devices are inappropriate in certain areas, such as in restrooms and elevators, where the sound level could cause disorientation and would be an annoyance.

Examples: In elevators, occupants cannot exit until the car stops and the doors open; on stairwells, the devices would be in the path of egress (*i.e., path of occupants exiting due to emergency alarms*).

- Wall-mounted audible devices must be mounted between **80 and 96 inches** from the finished floor level, and at least **6 inches** below the ceiling.

Figure 44. Example of Correct Audible Device Installation on Ceiling

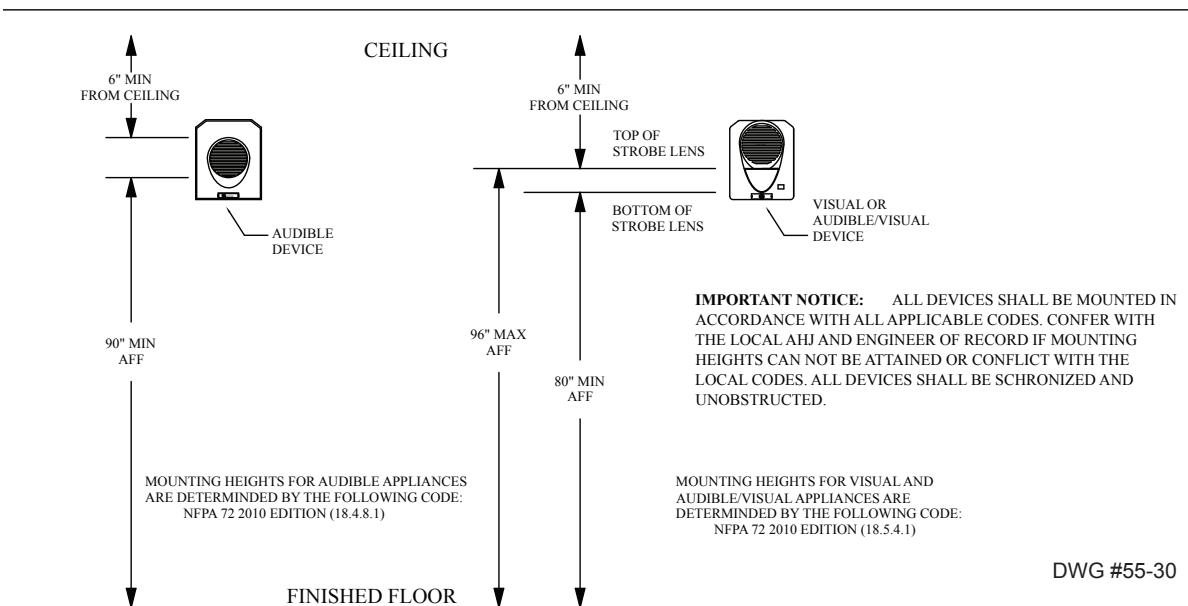

Table 9: Public vs. Private Mode Occupancy Audible Notification Requirements	
Occupancy Description	Minimum Sound Level
<p>Public Mode – Audible or visible signaling is provided as evacuation notification to occupants or inhabitants of the area protected by the fire alarm system.</p> <p><i>Examples: Business, educational, residential, sleeping areas, industrial and storage occupancies.</i></p>	<p>At least 15 dB above the <u>average ambient</u> or normal sound level or 5 dB above the <u>maximum sound level</u> that lasts at least 1 minute.</p>
<p>Private Mode – Trained individuals are present 24 hours a day to take additional action when there is an emergency.</p> <p><i>Examples: Hospital patient care areas, operating rooms or critical care areas. In situations like these, sound levels must adequately notify the occupants to evacuate, but not too loud as to startle them.</i></p> <p><i>Note; Emergency signaling may not be required to meet ADA requirements or UL 1638</i></p>	<p>At least 10 dB above the <u>average ambient</u> or normal sound level or 5 dB above the <u>maximum sound level</u> that lasts at least 1 minute.</p>

- The total sound pressure produced by audible devices must not exceed 120 dB because hearing damage may occur.
- The level of sound made by the audible device reduces as the distance from the source is increased.

Note: To factor this in when selecting an audible device, double the distance from the source and the sound pressure (dB) will drop by 6 dB. Next, double the distance again and the sound pressure is decreased another 6 dB. Please keep in mind that when sound travels through walls and doors, the sound loss may be greater than 6 dB.

Example: Potter Electric's SLP/HSLP Outdoor Series Evacuation Signals devices may be used for both private- and public-mode based on the required minimum sound level required for the facility.

- In private facilities, it can produce a dBA range of 66-74 dBAs.
- In public facilities, it can produce a dBA range of 70-82 dBAs (*i.e., when set on the highest dBA setting*).

Figure 45. Potter's SLP/HSLP Outdoor Series Evacuation Signals



Public & Private Modes Occupancy Requirements

The NFPA 72 makes a distinction between public and private mode facilities as described in the following table:

Visual Notification Requirements

A visual notification device is any device that alerts an occupant by sight of an emergency, such as a *strobe or rotating beacon*. The *Americans with Disabilities Act (ADA)* and the building code being used for the occupancy determines the type of notification devices required.

Notes:

1. Refer to *NFPA 72, 2013 Sections 18.4–18.9* for more information on these topics.
2. The ADA and NFPA share the same installation, operation and location requirements for visual notification devices. For more information on ADA's audio and visual notification requirements, refer to: http://www.ada.gov/ada_req_ta.htm.

Strobes are required in all new construction, in renovations to portions of buildings open to the general public, and when any portion of the building is accessible to a hearing impaired person.

Other visual notification requirements to consider:

1. If a facility is not open to the public and no employees have hearing disabilities, strobes are not required.
2. If an employee with a hearing disability works in an office, strobes may be required in their office, conference rooms, restrooms, hallways, and routes of tours.
3. In commercial facilities, strobes must be located in areas accessible to the public and to occupants of the facility who may have hearing disabilities.

Figure 46. Examples of Potter's Selectable Candela Horn/Strobe (S-24/HS-24) & Selectable Candela Ceiling Mount Strobe (CS/CHS)



Installation Orientation

Some visual appliances (*only if approved and UL listed*) may be installed in either a *wall mount or ceiling mount orientation*. Others, such as "*flashing strobes*," must be installed in the orientation it has been listed and approved by UL. This section explains the different requirements for wall-mounted vs. ceiling-mounted devices.

Wall Mounting Considerations

The NFPA 72 allows three (3) wall mount strobe configurations:

1. A single device per area
 2. Two devices per area
 3. Four devices per area
- Spacing requirements are based on the square area covered by a single device.
- Note:** The largest room area allowed to be covered by a single wall mounted device is **70 ft. x 70 ft.**
- Wall mount strobes cannot be mounted on ceilings for visual notification. Only devices rated for both wall- and ceiling-mount installation may be used.
 - Wall mount strobes must be mounted between **80 and 96 inches** from the finished floor level, and at least **6 inches below** the ceiling.
 - When more than two strobes are in the field of vision (*i.e., corridors*), the strobes must be synchronized to flash at the same time. Some people are photosensitive and may have an epileptic seizure if exposed to random flashing lights.

Figure 47. Example of Wall-Mounted Strobe Installed in 40 Ft. x 20 Ft. Room

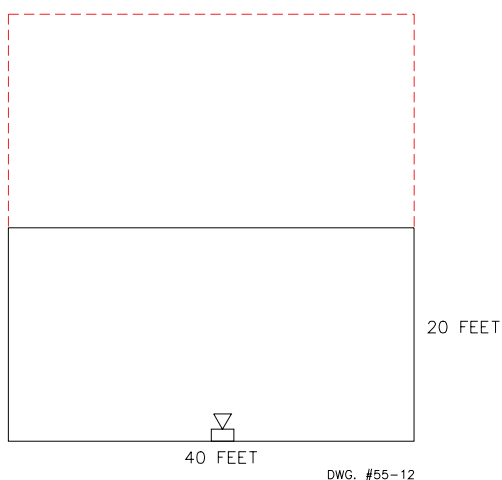

Ceiling Mounting Considerations

- The **maximum ceiling height** of any ceiling mounted strobe is **30 feet**.
- If the ceiling height **exceeds 30 feet**, the visual devices must be suspended or wall mount strobes must be used.
- The **maximum room area** covered by a ceiling mounted strobe is **50 feet by 50 feet**.
- The strobe **must** be mounted in the **center of the room** to achieve the light levels as specified in the tables in NFPA 72.
- If the strobe is **not mounted** in the center of the room:
 1. Measure the distance from the strobe to the farthest wall.
 2. Double the measured distance to determine the room size for the strobe to be used. **Example:** The strobe in this example is set off center by five (5) feet. The farthest wall is 15 feet, and when doubled is 30 feet. The strobe size used in this room must meet the minimum requirements of a strobe used in a 30 ft. x 30 ft. room.

Figure 48. Example of Ceiling-Mounted Strobe Installed Off-Center

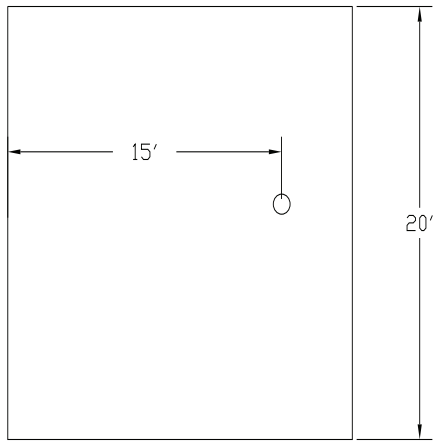

DWG. #55-13

Corridor Installation Requirements

When visual notification devices are installed in *corridors*, specific NFPA 72 requirements must be followed. For example, the corridor must be *less than 20 feet wide* to be considered a corridor. Otherwise, the corridor must be treated as a room, and must meet the same lighting requirements.

When visual devices are required in corridors:

- The corridor must be less than 20 feet wide.
- The minimum candela rating is 15 cd.
- The strobes must be mounted within 15 feet of the end of the corridor.
- They cannot be spaced more than 100 feet apart on center.
- May be mounted either on the wall or the ceiling.
- They must be mounted in accordance with NFPA 72 for the proper height and placement.
- If there are any interruptions, such as partitions or changes in elevation, the areas must be considered separate areas.
- When more than two strobes are in the field of vision, the strobes must be **synchronized** to flash at the same time since some people are photosensitive and may have an epileptic seizure if exposed to random flashing lights.

Candela Light Output Rating

Visual notification devices are rated on their **light output or candela (cd)**. The light output intensity (*i.e., candela rating*) of a strobe is measured based on the amount of *square area covered*. Strobe devices must provide a **minimum** of **15 cd light output** directly in front of the device.

Note: Any strobe device listed for evacuation **must** comply to all light output requirements to be UL listed.

Some manufacturers, including Potter Electric, design visual devices with several options and light output settings based on room size and the number of visual devices installed per room (*i.e., multiple- and split-candela rated*). Several examples are provided in this topic.

NFPA's Light Output Candela Requirements

The following two charts show NFPA 72's light output requirements for ceiling- and wall-mounted devices based on room size / dimension, and ceiling height maximums.

Table 10: Minimum Light Output Requirements for Ceiling-Mounted Appliances				
Maximum Room Size		Maximum Ceiling Height		Minimum Required Light Output (Effective Density) One Light (cd)
m	feet	m	feet	
6.1 x 6.1	20 x 20	3.05	10	15
9.14 x 9.14	30 x 30	3.05	10	30
12.1 x 12.2	40 x 40	3.05	10	60
15.2 x 15.2	50 x 50	3.05	10	95
6.1 x 6.1	20 x 20	6.1	20	30
9.14 x 9.14	30 x 30	6.1	20	45
12.1 x 12.1	40 x 40	6.1	20	80
15.2 x 15.2	50 x 50	6.1	20	115
6.1 x 6.1	20 x 20	9.14	30	55
9.14 x 9.14	30 x 30	9.14	30	75
12.1 x 12.1	40 x 40	9.14	30	115
15.2 x 15.2	50 x 50	9.14	30	150

Table 11: Minimum Light Output Requirements for Wall-Mounted Appliances			
Maximum Room Size (shown in feet)	One Light per Room (shown in cd)	Two Lights per Room (Located on Opposite Walls)	Four Lights per Room (One Light per Wall)
20 x 20	15	NA	NA
28 x 28	30	Unknown	Unknown
30 x 30	34	15	NA
40 x 40	60	30	15
45 x 45	75	Unknown	Unknown
50 x 50	94	60	30
54 x 54	110	Unknown	Unknown
60 x 60	135	95	30
70 x 70	184	95	60
80 x 80	240	135	60
90 x 90	304	185	95
100 x 100	375	240	95
110 x 110	455	240	135
120 x 120	540	305	135
130 x 130	635	375	185

NA = Not Allowable

Multiple Candela Rated Visual Devices

These type of visual devices can produce a range of light outputs based on the room or area size requirements.

Examples: Potter Electric's *CS/CHS strobe*, shown below, has six selectable settings: 15, 30, 75, 95, 115, and 150 cd. The *SPKSTR-24WLP speaker/strobe* has similar setting options, and a fixed 15/75 cd split rating available.

Figure 49. Potter's CS/CHS Strobe/Horn



Figure 50. Potter's SPKSTR-24WLP Low Profile Speaker/Strobe



In the next example, Potter Electric's *CCHS-24 Ceiling Mount Horn Strobe series* **OR** *CCS-24 Strobe series* is rated for wide range of applications, including severe weather, extreme temperatures, mass notification and others.

Figure 51. Potter's CCHS-24 Ceiling Mount Horn Strobe series



Remote Annunciators

Remote Annunciators are commonly required in certain facilities, such as in schools, multi-level buildings, hospitals, and large commercial buildings. They are usually located near the front entrance of a building so that the emergency teams can quickly locate the area of alarm. They may or may not show all alarm devices (*referred to as "points"*) throughout the building. This information helps the emergency team to efficiently deploy where needed.

Note: Refer to *NFPA 72 2013, Sections 18.11 and 10.18-A.10.18.3* for more information on this topic.

Types of Annunciators

When remote annunciators are required by the AHJs, they may also require that a specific type of remote annunciator is used, and installed in a specific location (*i.e., front entrance of building, every floor, etc.*).

There are three (3) types of remote annunciators: *LED, LCD and Graphic displays.*

- **LED annunciators** – these are usually simple devices indicating which zones are in *Alarm, Supervisory, or Trouble*. They also may have some control features, such as Silence and System Reset.
- **LCD annunciators** – these provide a text display indicating the status of the fire alarm system. Most LCDs also allow for common control functions and some programming.
- **Graphic displays** – these are large boards that have a footprint of the entire building usually by floor. They have LEDs that show the different devices mounted throughout the building.

Below are examples of Potter Electric's LED and LCD remote annunciators.

Figure 52. Examples of Potter's Remote LED Annunciator (LED-16) and LCD Annunciator (RA-6500)



Fire Alarm Signals

There are three (3) main signal types that may display on a fire panel and LCD remote annunciator when an "off-normal" condition occurs:

1. Alarm
2. Supervisory
3. Trouble

Note: Refer to *NFPA 72 2013, Sections 10.7-10.8, 3.3.244, and 3.3.257* for more information on this topic.

It's important to understand the distinction between each of these signal types, so you respond accordingly. When one of these signals are initiated, information is also transmitted to a remote monitoring company.

Note: For more information on transmitting data between the fire alarm panel and a monitoring or supervisory station, please refer to "*Section 6: Communications Technology*" in this manual.

There are many reasons an "off-normal" condition may occur. The table below briefly summarizes some possible causes for each signal type.

Table 12: Fire Alarm Signals		
Signal Types	Possible Conditions	Action Required
Alarm	The following conditions may exist: <ul style="list-style-type: none"> • Automatic water flow device (<i>i.e., flow switch</i>) • Manual fire alarm station (<i>i.e., pull station</i>) • Automatic fire detectors (<i>i.e., smoke or heat detectors</i>) 	Indicates an emergency that requires immediate action , such as a signal characteristic of a fire.
Supervisory	The following conditions may exist: <ul style="list-style-type: none"> • Control valve switch • High/low air pressure switch • Water tank level and temperature switches • Low water pressure for public water supplies • Low building temperature switch • Alarm line valve position 	Indicates that action must be taken by an on-site supervising guard to inspect the fire suppression systems or equipment, or the maintenance of related systems.
Trouble	The following conditions may exist: <ul style="list-style-type: none"> • Loss of primary power (120VAC) • Loss of secondary power (backup battery) • A break in the wiring to an initiating device, or an open or shorted condition on a notification appliance (NAC) or release circuit. 	Indicates a problem with the fire control panel or associated wiring, which may cause faulty system operation.

Section 6: Communications Technology

Throughout the last several decades, many new communication technologies have emerged that have greatly impacted the fire system industry. This section focuses on three of these technologies:

- Dialer or DACT/DACR (Digital Alarm Communicator Transmitter/Receiver)
- IP Communication
- Radio Systems

All of these technologies can report alarm, trouble or supervisory conditions to the fire department or a remote monitoring company. However, before the system designer selects the communications method for a facility, they should evaluate many factors, such as cost or budget constraints, capabilities of the fire alarm system, and Building Code and AHJ's requirements.

At the end of this section, you'll see a chart that compares and contrasts these three technologies. The chart summarizes each technologies' advantages, limitations or disadvantages, and things to consider.

Notes:

1. Please refer to *NFPA 72 2013, 26.6.1 – 26.6.3.2.2.2* for more details on communication technologies.
2. All communications technology must conform to *NFPA 70, National Electrical Code*.

Digital Alarm Communicator Transmitter (DACT)

DACT Overview

DACT technology has been available for more than 20 years. They are usually connected to a fire alarm panel using two plain old telephone service (POTS) lines via an RJ-31X jack.

Below is a basic diagram of how a DACT/DACR communications system is configured:

Figure 53. Example of DACT Communication Pathway Setup

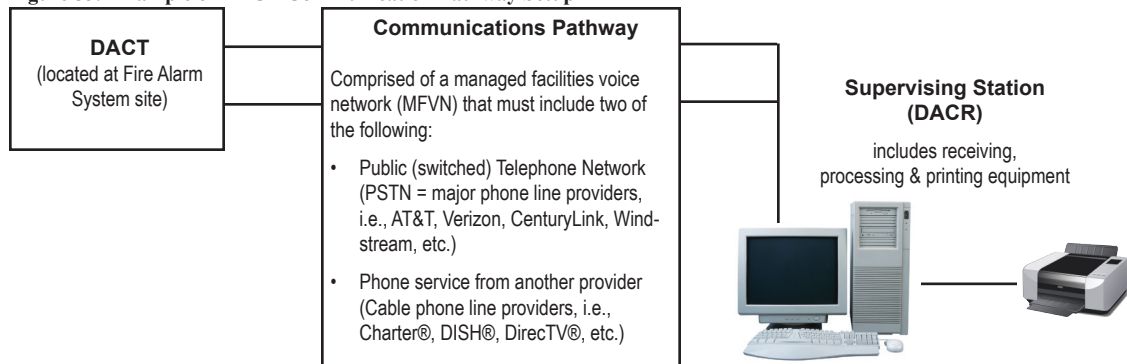

Equipment Requirements for DACT Communications

1. **DACT equipment must be installed before any other telephone equipment.** This ensures that the DACT can immediately seize the phone line in order to transmit a signal to the DACR (*receiver equipment*) located at the control station. If necessary, it may disconnect an outgoing or incoming call.
2. **Two reliable communication methods consisting of a primary and secondary transmission channel.**
 - DACTs may be programmed to call a second DACR line number if the signal transmission to the 1st phone number fails.
 - Simultaneous transmission over both channels is allowed.

3. The primary transmission method must be a telephone line (PSTN).

- PSTN or Public Switched Telephone Network includes land phone service providers, broadband service providers, cable service providers, long-distance service providers, and others.
- Most PSTN providers meet the MFVN (Managed Facilities Voice Network) standards, which ensures that the line connection provides a telephone circuit that has the operational equivalency of traditional PSTNs.

Example: Some VOIPs (*Voice Over IP systems*) do **not** provide consistent, reliable service. These service providers may not meet MFVN standards.

- Party lines cannot be used!

4. The secondary transmission method may be any one of the following:

- One-way private radio alarm system
- Two-way RF multiplex system
- Cell phone
- IP communication, GSM, or other method that complies with *NFPA 72, 2013, 26.6.3.1*.
- PSTN telephone line (allowed only if an alternative method is not available and the AHJ approves its use)

Notes:

- *If a 2nd telephone is used, each telephone number must be tested at alternating 6-hour intervals.*
- *If a long distance service is used (including WATS), the 2nd phone number must be provided by a different long-distance service provider.*

Transmission Requirements for DACTs

1. The "off-hook" back to "on-hook" time cannot exceed 90 seconds per attempt!

The "off-hook" to "on-hook" cycle includes the following steps:

- DACT seizes a phone line
- Gets a dial tone
- Dials DACR phone number
- Receives "*handshake*" from DACR
- Transmits data
- Receives acknowledgment signal
- Releases phone line

2. Reset and retry if the 1st attempt to complete a signal transmission fails.

- At least a **minimum of 5 attempts** up to a **maximum of 10 attempts** must be completed.

Note: If another alarm occurs from another initiating device or SLC, the DACT will try the signal transmission again.

- If the maximum number of attempts fails to connect successfully, then a "**failure**" **condition** must be annunciated at the originating location (*i.e., at the facility's fire panel*).
- If a transmission fails to connect to the DACR, a "**failure**" **condition** must be annunciated (*visually and auditorily*) at the supervising station.

3. Verify that the signal was received.

- The primary channel must be able to deliver a message from the supervising station (DACR) back to the DACT indicating that the transmission was received.
- If either channel fails to send a trouble signal, the 2nd transmission channel must send the trouble signal **within 4 minutes**.
- When one transmission channel has failed, all status change signals must be sent over the 2nd channel.

4. Test that the transmission between the DACT and DACR is successful. Testing should be done when the DACT is first installed, or each time the facility changes telephone service providers.

Reminder: Some service providers do not provide the same level of circuit reliability service as traditional PSTN providers, *i.e., VOIP providers*.

5. The DACT must automatically test both transmission methods daily at least once every 6 hours!

IP Communications

The use of Internet Protocol (IP) communication is growing in the fire system industry because it's more cost effective and flexible than DACTs. Some manufacturers, like Potter Electric, have built-in IP communication.

Note: Please refer to *NFPA 72 2013, Sections 26.6.2.1 – 26.6.3.1.15.2, 10.14.1, and 10.6.7.3* for information on these topics.

IP Communications Overview

IP communication allows signals to be transmitted quickly and efficiently from a fire alarm control panel to a monitoring station receiver. The signal is sent using the existing network infrastructure located at a customer site. This point is important because the customer's network must be compliant with the application it is being used for otherwise the IP transmission will be inconsistent and unreliable.

Once the signal leaves the customer site, it enters the “*mesh*” network of the *World Wide Web*, which provides multiple redundant paths. This guarantees successful signal transmission to a central station, and is why IP signal transmission is faster and more cost effective than other types of signal transmission.

The diagram below shows how a basic IP communications system is configured:

Figure 54. Example of IP Communication Pathway Setup

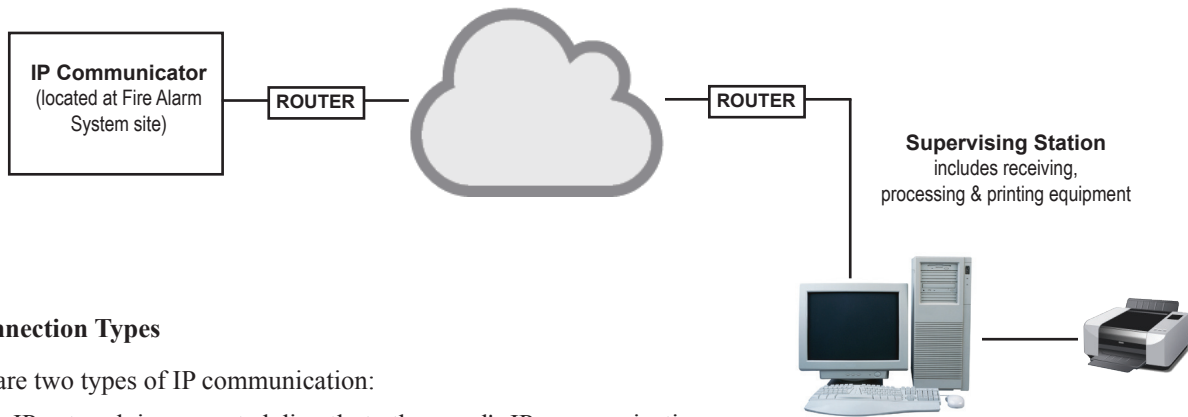

IP Connection Types

There are two types of IP communication:

1. An IP network is connected directly to the panel's IP communication.
2. An intermediary module, such as an IP data capture module or a dialer capture module, converts the data to IP.

Example: An IP Data Capture module is used in conjunction with a DACT. It connects to the DACT output of the fire alarm control unit and converts the output data into IP.

Equipment Requirements for IP Communications

1. **Sharing Communications Equipment On-Premises.** If the fire alarm transmitter is sharing on-premises communications equipment, the shared equipment **must** be listed as communications or information technology equipment.

Note: Most communications equipment is not specifically listed for fire alarm applications, but is listed in accordance with applicable product standard for general communications equipment and is acceptable.

2. **Secondary Power at Protected Premises.** This requirement is to ensure that communications equipment will operate for the same period of time on secondary power as the alarm control unit.

Secondary power supply at the protected premises must be capable of transmitting alarm, supervisory, trouble, and other signals as follows:

- It does not have to be a dedicated power supply, *i.e., generator*, to the fire system.

Note: Most installations already have the equipment connected to an UPS.

- If the fire alarm transmitter is sharing communications equipment, the shared equipment must have a 24-hour secondary power capacity.

Exception: The AHJ may allow less than a 24-hour backup power supply if a risk analysis is performed to ensure acceptable availability is provided (*i.e., minimum of 8 hours has been found acceptable*).

Transmission Requirements for IP Communications

Maximum Operating Time

- Maximum allowable time lapse for initiation of a single alarm signal until it is recorded at the supervising station is **90 seconds**.
- If multiple subsequent alarms occur, each signal must be recorded at the supervising station no slower than every **10 seconds**.
- Maximum allowable time lapse from the occurrence of an adverse condition in any transmission channel until recording of the adverse condition cannot exceed **200 seconds**.

Communication Path Requirements

1. Single Communication Path

- If only one communications path is used, the failure must be annunciated at the supervising station **within 60 minutes**.
- If a single technology is used, it's important to evaluate the potential risk exposure that results from the loss of that path for any period of time and for any reason.

Example: The Potter P-Comm and FCB-1000 IP Communicators can be a single source for transmitting signals to the central station eliminating the need for another technology. The supervising station will annunciate a "*failure of the communication path*" message in 90 seconds or less.

2. Multiple Communication Paths

- Each path must be supervised **every 6 hours or less**.
- If a failure occurs on any path, it must be annunciated and recorded at the supervising station within **6 hours or less**.
- If a transmission fails on all paths, it must be annunciated visually and audibly at the protected premises **within 90 seconds**.
- A single technology may be used to create multiple communication paths.

Radio Systems

Radio transmission systems, like IP communications, are becoming more commonplace in the fire alarm system industry. Because of new technologies, many wireless devices may be part of a network. Smartphones' software, mobile networks and broadband wireless infrastructure have all contributed to the viability of using radio communications to transmit data between a fire alarm panel and a monitoring station.

Note: Please refer to *NFPA 72 2013, 26.6.3.1.15.1 – 26.6.3.3.2.7, 24.5.2, and 27.4.3.5, 27.5.5.3.3*, for more information on radio communication topics.

Radio Systems Overview

There are two-way radio frequency (RF) multiplex systems, and one-way private radio alarm systems. Both systems are briefly explained in this section.

Two-Way Radio Frequency (RF) Multiplex Systems

Two-way RF multiplex systems (*Type 4 only*) consist of a traditional multiplex, where transmissions are sent/received across the same radio frequency. This process is called the **"interrogation-response" transmission sequence**.

Note: There are two types of two-way radio, Types 4 and 5. They are briefly explained under the *"Equipment Requirements"* heading in this topic.

For example, a fire alarm system using a two-way radio:

- Sends an interrogation (*or test*) signal from the protected premises to the supervising station, and
- Responds to the received signal from the supervising station and replies back to the protected premises.

The *"interrogation-response"* transmission sequence ensures the integrity of the overall multiplex system, and operates transparently over the radio portion of the system. The diagram below shows a two-way RF communications configuration:

Figure 55. Example of Two-Way Radio Frequency Communication Pathway

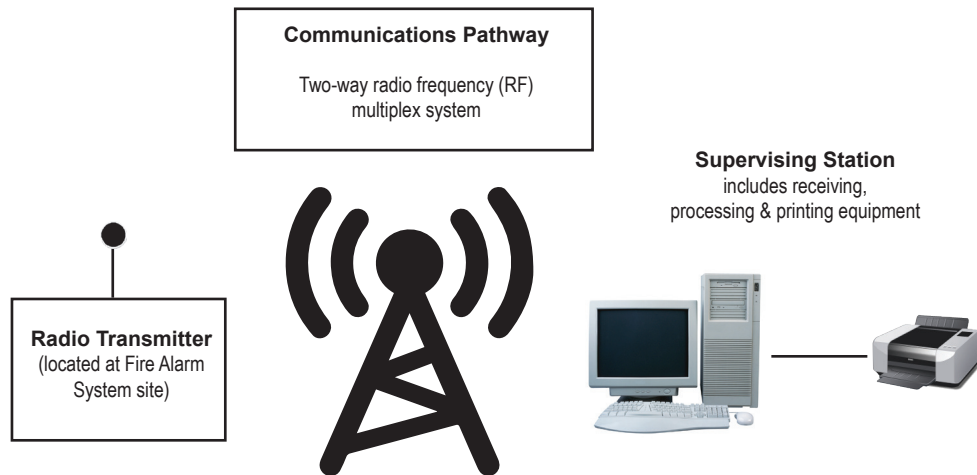

Equipment Requirements for Two-Way Radio

1. Radio systems must use a **licensed** two-way radio for fire alarm system signaling.

- This is required because the FCC has restricted the number of times an unlicensed radio transmitter may transmit information during a 1-hour period.
- The FCC has set aside a portion of the radio spectrum for specific use by radio "telemetry" applications only (*i.e., fire alarm, supervisory and trouble signals, meteorological weather balloons, spacecraft, medical equipment, etc.*).

2. **Radio receivers using antennas to transmit an RF signal must be protected to reduce the possibility of lightening or static discharge damage.**
 - Antennas include wire-string type, multi-element, vertical rod, dish and all wiring/cabling connecting them to equipment.
 - All receiver equipment must be installed in compliance with NFPA 70, National Electrical Code, Article 810.
3. **There are two types of two-way RF multiplex systems.**
 - **Type 4** has a redundant transmitter/receiver which should be selected for a facility when there is a high volume of traffic or unusual radio frequency propagation problems exist.
 - A transmitter/receiver (*referred to as a "transceiver"*) must be located at both sites (*i.e., protected premises and supervisory station*).
 - This type provides a higher level of reliability.
 - **Type 5** does not have redundancy, but provides the minimum level of system integrity that most applications require.

Transmission Requirements for Two-Way Radio Systems

1. **Type 4 requires that the protected premises has a 2-way transmitter (RAT-Radio Alarm Transmitter) using separate channels.** Likewise, the supervisory station's receiver must also use separate channels.
2. **Type 5 requires that the receiver must be located near two repeaters** (*refer to the "One-Way Radio" heading for more information on repeaters*).
3. **Supervisory station's transmitter must have access to any off-line transmitter every 8 hours.**
4. **Transmission failures must be annunciated at the supervisory station.**
5. **If a RF receiver fails, it cannot affect any other receiver.**
6. **If all receiving equipment at the supervisory station is duplicated, and switchover can be done within 30 seconds, then the "loading capacity" is unlimited.**

One-Way Radio Frequency (RF) Systems

One-way radio alarm communication doesn't have the "*interrogation-response*" capability like two-way transmissions. Because of this, a **RAT (Radio Alarm Transmitter)** and either one or more **RARSR or RASSRs (Radio Alarm Repeater Station Receiver / Radio Alarm Supervisory Station Receiver)** are required.

Note: The number and type of required receivers depends upon the type of one-way radio alarm system being used.

The diagram below shows a one-way private radio alarm system configuration:

Figure 56. Example of One-Way Radio Alarm System Communication Configuration

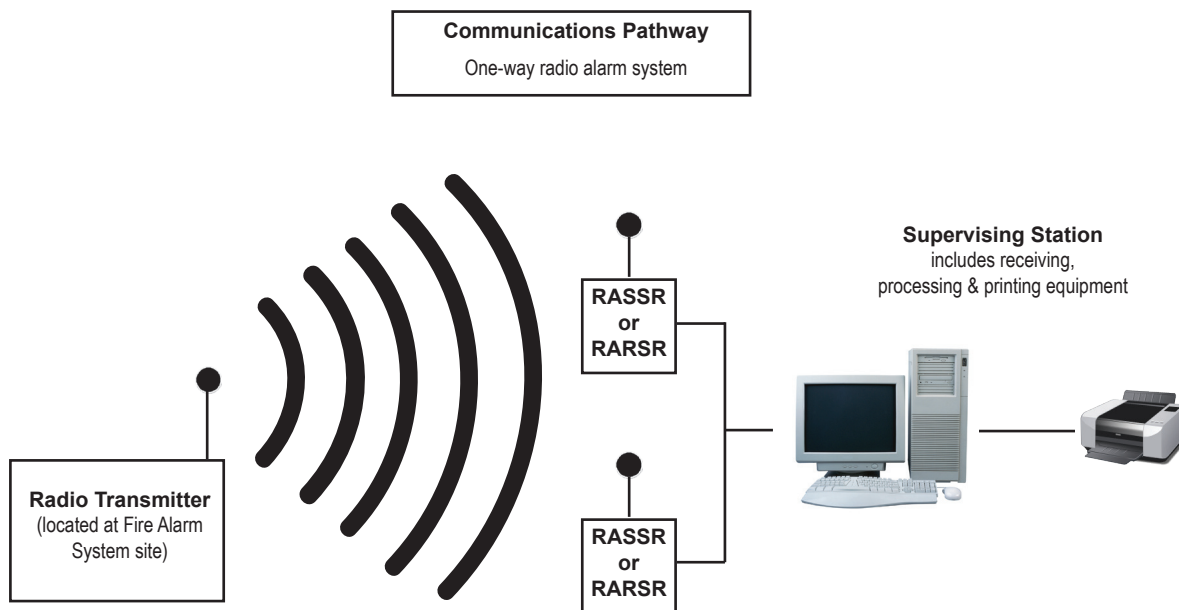

Equipment Requirements for One-Way Radio

1. A radio alarm transmitter (RAT) must be located at the protected premises to transmit alarms.
2. One or more receivers (RARSR/RASSRs) are required, based on radio type. Receivers improve the transmission integrity and ensure that it is successfully received at the supervisory station.
3. Type 6 must have a minimum of two RARSR/RASSRs and serves one supervisory station.
4. Type 7 must have one RASSR and a minimum of two RARSRs. It serves more than one supervisory station.
5. Radio equipment must be supervised so that all failures will be annunciated at the supervisory station.
6. All wiring between the radio equipment and antennae must be in conduit.

Transmission Requirements for One-Way Radio Systems

1. The system must be monitored every 24 hours to ensure that at least two independent RARSRs are receiving signals for each transmitter (RAT).
2. If the two independent receivers (RARSRs) do not receive the transmission, the supervisory station must be notified.
3. When an alarm is transmitted, it must be recorded at the supervisory station within 90 seconds.
4. Signals must be sent to the supervisory station with the following minimum success rates:
 - 90% probability of successful transmission within 90 seconds
 - 99% probability of successful transmission within 180 seconds
 - 99.999% probability of successful transmission within 240 seconds
5. If all receiving equipment at the supervisory station is duplicated, and switchover can be done within 30 seconds, then the "loading capacity" is unlimited.

Comparison of DACT, IP & Radio System Communications

The table below summarizes some of the benefits, disadvantages and things to consider for each type of system communications method. Refer to *NFPA 72 2013, Table A.26.6.1* for more information on this topic.

Table 13: Comparison of DACT, IP and Radio System Communications Methods			
Type of Communications	Benefits	Disadvantages	Things to Consider
DACT Digital Alarm Communicator Transmission	<ul style="list-style-type: none"> Built-in function of the control panel or easy setup installation if not built in. Landline telephones may be used. 	<ul style="list-style-type: none"> Slower transmission than other methods since data must be converted from analog signal to digital and then back again to analog. Must be installed before any other telephone equipment. Cable phone lines may cause connection problems between the DACT and the Internet lines located outside the building (<i>i.e., protected premises</i>). If the cable box at the facility loses power, the DACT's signals will not successfully connect to the Internet. Fiber optic & cable phone lines are monitored only <u>once</u> every 24 hr. period. Some technologies have replaced copper phone lines, <i>i.e., VOIP</i>. 	<ul style="list-style-type: none"> Connection out of the building to the Internet may be unpredictable due to customer's type of phone line connection. If long-distance lines/service are used, 2nd line must be a different service provider. Standby backup batteries are limited to 8-hrs of power. FCC has changed the 24-hour testing rule to a 6-hr testing interval. FCC is considering the elimination of landline telephones making only broadband and IP-based services available. If call forwarding is used to communicate with the supervising station, it must be tested every 4 hours.
IP Internet Protocol	<ul style="list-style-type: none"> Fast, efficient Flexible Redundant pathways are available, <i>i.e., if one path fails to send signal, another path is used until signal is successfully sent.</i> Error detection and correction process ensures the right message is received at the monitoring station. 	<ul style="list-style-type: none"> Reliability is dependent on customer site's infrastructure (<i>i.e., fails to connect to the Internet/World Wide Web</i>). An IP communications card is required at the monitoring station for IP communication to work correctly. 	<ul style="list-style-type: none"> A secondary power supply must be available at the protected premises (<i>i.e., UPS</i>). The quality of the transmission is determined by the quality of the network communication.

Table 13: Comparison of DACT, IP and Radio System Communications Methods

Type of Communications	Benefits	Disadvantages	Things to Consider
<p>Radio Frequency Systems</p> <p>Two-Way RF Multiplex & One-Way RF</p>	<ul style="list-style-type: none"> • Two-way (<i>Type 4</i>) radios are reliable due to "interrogation-response" transmission sequence. • One-way radios are reliable because signal quality is continuously monitored. • Supervising station may poll all radios to ensure that the transmitter and receiver can respond. 	<ul style="list-style-type: none"> • Less secure data transmission. • Requires one or more RARSR or RASSR receiver to amplify transmission signals. • May require an engineered study to determine best locations of receivers (<i>RARSR / RASSR</i>) based on transmission interferences. • Signal integrity may be compromised due to unpredictable transmission interferences. • Requires a minimum of 2 independent RF paths used simultaneously. • Doesn't transmit alarm signal details to the supervising station. Only signal type is transmitted. 	<ul style="list-style-type: none"> • All infrastructure has to be in place. • FCC requires that 2-way radios are licensed. • Antenna must be protected to prevent/reduce static discharge or lightning damage. • One-way radio equipment must be continuously supervised so that failure is annunciated at the supervising station. • Wiring between the radio equipment and the antenna must be in conduit (<i>one-way radio only</i>).

Section 7: Battery & SLC Calculation Worksheets / Submittal Documentation

This section covers how to calculate notification device and SLC current draw, and the standby/alarm battery voltage needed for a fire alarm system. Several calculation methods are provided in this section to help you correctly calculate voltage drops, along with a few sample worksheets for your reference.

This section also provides a sample required submittal document, which must be provided to the AHJ before any fire alarm system is installed or implemented.

Note: Refer to *NFPA 72 2013*, 7.2 for additional information on submittal documentation.

Calculation Overview

The system designer must calculate the "*total circuit draw*" used by each device and appliance before installing any devices. If this step is skipped or compromised, the panel's notification circuit may not provide enough power to support the devices. Also, the standby batteries must be able to power the panel when "*standby*" and "*alarm*" conditions occur.

Note: Always refer to the fire alarm control panel's installation instructions for further guidance on notification circuits.

The system designer **must know** the following information to correctly calculate the voltage drop:

- Total current available per circuit
- Number of devices that will be connected
- Current draw of each device
- Minimum device operating voltage
- Length of the wire run and wire size

Notification Voltage Drop

The voltage drop that occurs on a Notification Appliance circuit is a result of the added resistance from the wire as the length of the wire run increases. The easiest way to calculate the voltage drop is to use a free calculator program provided by either the fire system's manufacturer, or the *Automatic Fire Alarm Associations' web site at www.afa.org*.

To calculate voltage drop:

1. Start with a panel voltage of **20.4 volts**, which is **85% of the nominal 24 volts**.
Note: This represents the minimum voltage at which the fire panel is required to operate, and is the worse case after the panel is operating on battery power for an extended period of time.
2. Calculate the wire resistance from the fire panel to the first appliance, and multiply that by the current draw of all appliances. Subtract that number from 20.4.
Note: The result represents the available voltage at the first appliance. Verify that the number is larger than the lowest operating voltage of the appliance.
3. Calculate the wire resistance to the next appliance, multiply that by the current draw of the remaining appliances and subtract that number from the voltage at the previous appliance.
4. Continue calculations for all appliances on the NAC circuit. Verify that the voltage at the last appliance is within the operating range of the appliance.

AWG#	Ohm's per 1000 feet
12	1.6
14	2.5
16	4.0
18	6.4
20	10.0
22	16.0

Note: Potter Electric's battery calculation worksheets include calculations for voltage drops on NACs.

Lump Sum Calculation Method

The *Lump Sum Calculation* method assumes that all appliances are installed at the end of the wire run. This method results in a large safety factor where extra power supplies may be required. Although this method errors on the side of safety, the installation cost may be driven up to cover the calculated need.

Battery Standby Calculations

All fire alarm systems are required to have a secondary power source, such as a back up battery. However, before a battery is selected, you should first calculate the minimum size batteries for standby (non-alarm state) and alarm times wanted for each application and SLC current draw. The alarm condition usually requires a higher current draw than standby mode.

Note: If the wrong batteries are installed in a specific application or incorrect current draw is used, the proper standby and minimum alarm time will not be present.

Fire alarm systems are usually either 12 volt or 24 volt. The batteries are rated at 12 volts and are also given an **amp hour rating** (referred to as "AH"). The standard amp hour rating is 4, 7, 8, 12, 18, 26, 28, 33 and 55. The 24-volt DC systems use two 12 VDC batteries wired in series to provide the required voltage and maintain the same amp rating. The 12 VDC systems use a single battery, however two batteries can be wired in parallel to double the amp hour rating.

Example: Potter Electric's IPA series fire systems require that the battery circuits are rated for 8 to 55 AH batteries to ensure that the panel's alarm operates for at least 24 hours and 5 minutes. The IPA series cabinet will house up to two (2) 8 AH or two (2) 18 AH batteries.

To calculate the total current draw:

1. The calculated totals of each initiating device types are totaled and multiplied by the standby current.
2. All of the standby currents, including the panel, all initiating devices, remote annunciators and any other auxiliary currents are added together in amps.
3. All of the alarm currents are added together in amps.
4. The **standby current** is then multiplied by the **number of standby hours** required.
5. The **alarm current** is then multiplied by the **number of minutes in alarm** expressed in hours (*i.e., 5 minutes divided by 60 minutes per hour = 0.084*).
6. Add the **standby current amp hour** and the **alarm current amp hour** together, then **multiply by 1.2**.

Note: The final number represents the minimum required amp hour rating (AH) to provide the necessary standby and alarm current.

Total Current Draw Formula:

$$[(\text{Standby Amps}) * (\# \text{ of hours of Standby})] + [(\text{Alarm Amps}) * (\% \text{ of hours in Alarm})] = \text{Total Current}$$

$$\text{Total Current (in Amp Hours)} * 1.2 \text{ (safety factor)} = \text{Minimum Battery Size Required}$$

Sample Battery Calculation Worksheet (Potter Electric's IPA-100 Fire Alarm Panel)

Battery Calculation Worksheet					
Description	Quantity	Standby (mA)	Total Standby (mA)	Alarm (mA)	Total Alarm mA)
Main board (IPA-100)	1	130	130	220	
LCD Remote RA-6075R		20		25	
LCD Remote RA-6500R / RA-6500F		20		50	
CA-6075 Class A Expander		12		44	
UD-1000 DACT		16		23	
PSN-1000/E Power Expander		15		15	
LED-16/LED-16(F) P-Link LED Module LED-Current (if applicable, see Note 6)		25 15		25 210	
DRV-50 LED Driver Module LED-Current (if applicable see Note 6)		25 10		25 215	
RLY-5 Relay Module Relay Current (if applicable, see Note 6)		25 10		35 135	
FCB-1000 Fire Communications Bridge		25		25	
FIB-1000 Fiber Interface Bridge		30		30	
SPG-1000 Serial Parallel Gateway		40		40	
MC-1000 Multi-Connect Module		10		10	
NAC 1					
NAC 2					
I/O 1					
I/O 2					
SLC Current Draw - calculated by SLC Worksheet					
		Total (ma)		Total ma	
		Convert to Amps	x 0.001	Convert to Amps	x 0.001
(*Refer to maximum allowable standby current) Total A:				Total A:	
	Multiply by standby hours		x ____	<u>60 minutes per hour</u> Alarm time (minutes) <i>Example:</i> 5 minute alarm: enter 12 10 minute alarm: enter 6	÷ ____
		Total Standby AH		Total Alarm AH	
				+Total Standby AH	
				Total AH	
				Efficiency Factor	÷ 0.85
				Required AH	

<p>*Maximum Allowable Standby Current (UL 24-Hour standby time)</p> <p>7 AH .230 A</p> <p>18 AH .619 A</p> <p>33 AH 1.151 A</p> <p>55 AH 1.930 A</p>	<p>Important Notes:</p> <ol style="list-style-type: none"> 1. FACP enclosure can house up to two (2) 18 AH batteries. Larger batteries require accessory enclosure, part #SSU00500. 2. NFPA 72 requires 24 hours of standby power followed by 5 minutes alarm activation. 3. NFPA 12, 12A requires 24 hours and five minutes of alarm activation. 4. Door holder circuits configured to disconnect upon AC loss need not be included in the battery standby calculation since they will not draw power during that time. Door holders will contribute to standby current draw when AC is present. 5. Total current must not exceed power supply rating (5.0A). 6. LED/Relay current must be accounted for in the battery calculations for the supply source.
--	---

Submittal Documentation

Before a fire alarm system is installed, the appropriate documentation **must** be submitted to the AHJ. The AHJ may request a wide variety of information, such as:

- Equipment specifications
- Shop drawings or engineering diagrams (*i.e., floor plan and riser drawings, control panel wiring diagrams, point-to-point wiring diagrams, conduit, conductor routing and typical wiring diagrams*)
- Input/output matrix
- Battery calculations
- Notification appliance circuit (NAC) voltage drop calculations

Note: Once the fire system is installed, a *Record of Completion*, an owner’s manual, as-built drawings, and site-specific software instructions should be delivered to the owner at the main fire alarm panel's location.

Shown below is an abbreviated sample of the **Record of Completion form**, which must be completed and provided to the AHJ after the operational acceptance testing is finished. (*Please note that this example is a condensed version of the latest form shown in NFPA 72, 2010, figure 10.18.2.1.1, which is twelve (12) pages long.*)

Record of Completion

Name of Protected Property: _____
 Address: _____
 Rep. of Protected Prop. (Name/Phone): _____
 Authority Having Jurisdiction: _____
 Address/Phone Number: _____

1. Type(s) of System or Service

_____ NFPA 72, Chapter 3 Local

If alarm is transmitted to location(s) off premises list where received:

_____ NFPA 72, Chapter 3 Emergency Voice/Alarm Service

Quantity of voice/alarm channels: ___ Single: _____ Multiple: _____

Quantity of speakers installed: _____ Quantity of speaker zones: _____

Quantity of telephones or telephones jacks included in system: _____

_____ NFPA 72, Chapter 4 Auxilliary

Indicate type of connection:

Local energy: _____ Shunt: _____ Parallel telephone: _____

Location and telephone number for receipt of signals: _____

_____ NFPA 72, Chapter 5 Remote Station

Alarm: _____

Supervisory: _____

_____ NFPA 72, Chapter 5 Proprietary

If alarms are retransmitted to public fire service communications center or others, indicate location and telephone number of the organization receiving alarm:

Indicate how alarm is retransmitted: _____

_____ NFPA 72, Chapter 5 Central Station

The Prime Contractor: _____

Central Station Location: _____

Means of transmission of signals from the protected premises to the central station:

_____ McCulloh _____ Multiplex _____ One-Way Radio

_____ Digital Alarm Communicator _____ Two-Way Radio

_____ Others

Means of transmission of alarms to the public fire service communications center:

(a) _____

(b) _____

Systems Location: _____

Appendix A: Glossary & Definitions

Table 15: Glossary / Definitions	
Term	Definition
Addressable Device	A fire alarm system component with discreet identification that can have its status individually identified, or that is used to individually control other functions.
Air Sampling-Type Detector	A detector that consists of a piping or tubing distribution network from the detector to the areas being protected. A fan in the detector housing draws air from the protected area back to the detector. The air is analyzed for products of combustion.
Alarm Signal	A signal indicating an emergency requiring immediate action, such as a signal indicative of a fire.
Alarm Verification	A feature of some automatic fire detection and alarm systems to reduce unwanted alarms. Smoke detectors must report alarm conditions for a minimum period of time, or confirm alarm conditions within a given time period after being reset, to be accepted as a valid alarm initiating signal.
Analog Initiating Device	An initiating device that transmits a signal indicating varying degrees of condition, such as smoke obscuration levels. As contrasted with a conventional initiating device which can only indicate an “on/off” condition.
Annunciator	A unit containing two or more indicator lamps, alphanumeric displays, or other equivalent means in which each indication provides status information about a circuit, condition, or location.
Approved	Acceptable to the “authority having jurisdiction”. Note: The National Fire Protection Association does not approve, inspect or certify any installations, procedures, equipment, or materials, nor does it approve or evaluate testing laboratories.
Authority Having Jurisdiction (AHJ)	Organization, office or individual responsible for “approving” equipment, an installation or a procedure.
Automatic Extinguishing System Operation Detector	A device that detects the operation of an extinguishing system by means appropriate to the system employed. Including but not limited to water flow devices.
Automatic Extinguishing System Supervision	Devices that respond to abnormal conditions that could affect the proper operation of an automatic sprinkler system or other fire extinguishing system. Including but not limited to control valves, pressure levels, room temperature, etc.
Automatic Fire Detectors	A device designed to detect the presence of fire or the products of combustion. Including but not limited to heat detectors, flame detectors, smoke detectors.
Auxiliary Fire Alarm System	A system connected to a municipal fire alarm system for transmitting an alarm of fire to the public fire service communication center. Fire alarms from an auxiliary system are received at the public fire service communication center on the same equipment and by the same methods as alarms transmitted manually from municipal fire alarm boxes located on streets.
Bandwidth	The transmission capacity of an electronic pathway such as a communications line, computer bus or computer channel.
Breakglass Fire Alarm Box	A fire alarm box in which it is necessary to break a special element in order to operate the box.
Ceiling	The upper surface of a space, regardless of height. Areas with a suspended ceiling would have two ceilings, one visible from the floor and one above the suspended ceiling.
Ceiling Height	The height from the continuous floor of a room to the continuous ceiling of a room or space.

Table 15: Glossary / Definitions	
Term	Definition
Ceiling Surfaces: Beam Construction / Girders	<p>Ceiling surfaces referred to in conjunction with the locations of initiating devices are as follows:</p> <ul style="list-style-type: none"> • Ceilings having solid nonstructural members projecting down from the ceiling surface more than 4 in. and spaced more than 3 ft., center to center. • Girders support beams or joists and run at right angles to the beams or joists. When the top of girders are within 4 in. of the ceiling, they are a factor in determining the number of detectors and are to be considered as beams. When the top of the girder is more than 4 in. from the ceiling, it is not a factor in detector location.
Central Station	A supervising station that is listed for central station service.
Central Station Fire Alarm System	A system or group of systems in which the operations of circuits and devices are transmitted automatically to, recorded in, maintained by, and supervised from a listed central station.
Class A Circuit	Class A refers to an arrangement of monitored initiating device, signaling line, or notification appliance circuits, which would permit a single open or ground on the installation wiring of these circuits from causing loss of the systems intended function.
Class B Circuit	Class B refers to an arrangement of monitored initiating device, signaling line, or notification appliance circuits, which would permit a single open or ground on the installation wiring of these circuits to cause loss of the systems intended function.
Combination Detector	A device that either responds to more than one fire phenomenon or employs more than one operating principle to sense one of these phenomenon. Typical examples are combination smoke/heat detectors or a combination rate of rise and fixed temperature heat detector.
Compatibility Listed	A specific listing process that applies only to two wire devices (such as smoke detectors) designed to operate with certain control equipment.
Crossover Cable	A network cable that crosses the transmit and receive lines. It is used to connect hubs and switches together.
Digital Alarm Communicator Receiver [DACR]	A system component that will accept and display signals from digital alarm communicator transmitters [DACT] sent over public switched telephone network.
Digital Alarm Communicator System [DACS]	A system in which signals are transmitted from a digital alarm communicator transmitter [DACT] located at the protected premises through the public switched telephone network to a DACR.
Digital Alarm Communicator Transmitter [DACT]	A system component at the protected premises to which initiating devices are connected. The DACT will seize the connected telephone line, dial a pre-selected telephone number to connect to a DACR, and transmit signals indicating a status change of the initiating device.
Display	The visual representation of output data other than printed copy.
DHCP (Dynamic Host Configuration Protocol)	The automatic assigning of temporary IP addresses to client machines logging into an IP network.
Ethernet	A system for connecting a number of computer systems to form a local area network (LAN), with protocols to control the passing of information. This is the global standard for cabling computers together in a network. The wireless version of Ethernet is referred to as "Wi-Fi."

Table 15: Glossary / Definitions

Term	Definition
Ethernet Cables	An interface between a device and the network. <i>See also "crossover cable" and "straight through cable."</i>
Evacuation	The withdrawal of occupants from a building. Note: Evacuation does not include relocation of occupants within a building.
End Of Line Device	A device, such as a resistor or diode, placed at the end of a Class B circuit to maintain supervision.
End Of Line Relay	A device used to supervise power [usually for 4-wire smoke detectors] and installed within or near the last device on an initiating circuit.
Evacuation Signal	Distinctive signal intended to be recognized by the occupants as requiring evacuation of the building.
Exit Plan	Plan for the emergency evacuation of the premises.
Fire Alarm Control Unit (Panel)	A system component that receives inputs from automatic and manual fire alarm devices and may supply power to detection devices and transponders or off-premises transmitters. The control unit may also provide transfer of power to the notification appliances and transfer condition of relays or devices connected to the control unit. The fire alarm control unit can be a local unit or a master control unit.
Fire Rating	The classifications indicating in time [in hours] the ability of a structure or component to withstand fire conditions.
Fire Safety Functions	Building and fire control functions that are intended to increase the level of life safety for occupants or to control the spread of harmful effects of fire.
Flame Detector	A device that detects the infrared, ultraviolet, or visible radiation caused by fire.
Four Wire Smoke Detector	A smoke detector that has two distinct circuits used in its operation. The first circuit provides resettable power for the detector and the second circuit monitors the contact on the device. These types of devices are not listed for compatibility.
Heat Detector	A device that detects abnormally high temperature or rate of temperature rise.
IP or Internet Protocol	Refers to a network that uses TCP/IP communications protocol, which may be a wide area network (WAN) such as the public Internet, or a private, local network (LAN). <i>See also TCP/IP.</i>
IP Address	The address of a device attached to an IP network (TCP/IP network). Every device is assigned an IP address, and every IP packet traversing an IP network contains a source IP address and a destination IP address. <i>See also "DHCP."</i>
Initiating Device	A system component that originates transmission of a change of state condition, such as a smoke detector, water flow switch, etc.
Initiating Device Circuit	A circuit to which automatic or manual initiating devices are connected.
Ionization Smoke Detector	A smoke detector that has a small amount of radioactive material which ionizes the air in the sensing chamber, thus rendering it conductive and permitting a current to flow between two charged electrodes. This gives the sensing chamber an effective electrical conductance. When smoke particles enter the sensing chamber they decrease the conductance of the air by attaching themselves to the ions, causing a reduction in mobility. When conductance is reduced to less than a predetermined level, the detector responds.

Table 15: Glossary / Definitions	
Term	Definition
LAN or Local Area Network	A communications network that is typically confined to a building or premises. The "clients" are user workstations running an operating system, while the "servers" hold the programs and data shared by the clients.
Level Ceilings	Those ceilings that are actually level or have a slope of less than 1 1/2 in. per foot.
Light Scattering	The action of light being reflected and/or refracted off particles of combustion for detection by a photoelectric smoke detector.
Line Type Detector	A device in which detection is continuous along a path. Examples include projected beam smoke detectors and heat sensitive cable.
Listed	<p>Equipment or materials included in a list published by an organization acceptable to the "authority having jurisdiction" and concerned with product evaluation, that maintains periodic inspection of production of listed equipment or materials and whose listing states either that the equipment or material meets appropriate standards or has been tested and found suitable for use in a specific manner.</p> <p>Note: The means for identifying listed equipment may vary for each organization concerned with product evaluation, some of which do not recognize as listed unless it is also labeled. The "authority having jurisdiction" should utilize the system employed by the listing organization to identify a listed product.</p>
Local Fire Alarm System	A local system sounding an alarm at the protected premises as the result of the operation of automatic or manual initiating devices.
Manual Station (or pull station)	A manually operated device used to initiate an alarm signal.
MAC Address (Media Access Control)	The unique, physical address or serial number of a device.
National Fire Protection Association (NFPA)	Administers the development of and publishes codes, standards, and other materials concerning all phases of fire safety.
Nationally Recognized Testing Laboratory (NRTL)	A laboratory that is recognized by the Occupational Safety and Health Administration as meeting the necessary qualifications specified in the Code of Federal Regulations. Common NRTL in the United States that deal with fire alarm products are FM Approvals, Intertek Testing Services (ETL) and Underwriters Laboratories Inc. (ULI).
Network Protocols	The format and procedure that governs the transmitting and receiving of data in a network.
Networking	The exchange of information in any combinations of voice, video and/or data between users. The network includes the network operating system in the client and server machine, the cables connecting them, and all supporting hardware between. In wireless systems, antennas and towers are also part of the network.
Non restorable Initiating Device	A device whose sensing element is designed to be destroyed in the process of operation.
Notification Appliance	A fire alarm system component such as a bell, horn, speaker, strobe, etc. that provides an audible or visible output or both.
Notification Appliance Circuit (NAC)	A circuit directly connected to a notification appliance.
Obscuration	A reduction in the atmospheric transparency caused by smoke. Usually expressed in percent per foot.
Particles of Combustion	Substances resulting from the chemical process of a fire.

Table 15: Glossary / Definitions

Term	Definition
Photoelectric Smoke Detector	A smoke detector utilizing a light source and a photosensitive sensor so arranged that the rays from the light do not normally shine on the photosensitive sensor. When smoke enters the light path, some of the light reflects off the smoke onto the sensor, causing the detector to respond.
Proprietary Fire Alarm System	An installation of fire alarm systems that serve contiguous and noncontiguous properties under one ownership from a proprietary supervising station located at the protected property.
Rate Of Rise Heat Detector	A device which will respond when the temperature rises at a rate exceeding a predetermined amount [usually about 15 degrees per minute].
Remote Station Fire Alarm System	A system installed in accordance with NFPA 72 to transmit alarm, trouble and supervisory from one or more protected premises to a remote location at which appropriate action is taken.
Restorable Initiating Device	A device whose sensing element is not ordinarily destroyed in the process of operation. Restoration may be manual or automatic.
Router	Connects two different types of networks, i.e., WAN and LAN. It is a network device that forwards packets from one network to another.
Shall	In NFPA literature indicates a mandatory requirement.
Should	In NFPA literature indicates a recommendation or that which is requested but not required.
Signaling Line Circuit	A circuit or path between any combination of circuit interfaces, control units, or transmitters over which multiple system input signals or output signals, or both are carried.
Sloping Ceiling	Ceilings having a slope of more than 1 1/2 in. per foot.
Sloping – Peaked Type	Ceilings in which the slope is in two directions from the highest point. Curved or domed ceilings may be considered peaked.
Sloping – Shed Type	Ceilings in which the high point is at one side with the slope extending toward the opposite side.
Smooth Ceiling	A surface uninterrupted by continuous projections such as solid joists, beams or ducts, extending more than 4 in. below the ceiling surface.
Solid Joist Construction	Ceilings having solid structural or nonstructural members projecting down from the ceiling surface a distance of more than 4 in. and spaced at intervals 3 ft. or less, center to center.
Spot Type Detector	A device whose detecting element is concentrated at a particular location. Examples include certain smoke and heat detectors.
Straight Through (or Patch) Cable	A specific length of cable terminated at each end with a plug or socket.
Stratification	An effect that occurs when air containing smoke particles or products of combustion is heated by burning material, rises until it reaches a level where there is no longer a temperature difference between it and the surrounding air.
Story	The portion of a building included between the upper surface of a floor and the upper surface of a floor or roof next above.
Supervision	The ability to detect a fault condition in the installation wiring which would prevent normal operation of the fire alarm system.

Table 15: Glossary / Definitions	
Term	Definition
Supervisory Signal	A signal indicating an “off normal” condition on the fire suppression system. Examples include, tamper indication, low air pressure and low building temperature.
Switch	An electronic device that directs the flow of electrical signals routing a packet to a specific IP address.
TCP/IP	Transmission Control Protocol/Internet Protocol is the most widely used communications protocol. TCP/IP is commonly referred to as just "IP," which is the network layer of the protocol.
Thermal Lag	The difference between the operating temperature of a thermal detector and the actual air temperature.
Two-Wire Smoke Detector	A smoke detector that initiates an alarm condition on the same pair of wires that supply power to the detector.
WAN or Wide Area Network	A long-distance communications network that covers a wide geographic area, such as a state or country. Telephone companies and cellular carriers deploy WANs to service large regional areas or the entire nation.

Appendix B: Control Panel Symbols













Table 16: Control Panel Symbols	
Symbol	Description
	Control panel basic shape
	Fire alarm control panel
	Fire systems annunciator alarm
	Annunciator panel, from NECA 100, symbol 7.006
	Fire alarm transponder or transmitter
	Elevator status / recall
	Fire alarm communicator
	Fire system control panel
	Halon
	Carbon Dioxide
	Dry chemical
	Foam
	Wet chemical
	Clean agent
	Water mist
	Deluge sprinkler

Table 16: Control Panel Symbols

Symbol	Description
<div style="border: 1px solid black; padding: 2px; display: inline-block;">HVA</div>	Control panel for heating, ventilation, air conditioning, exhaust stairwell pressurization, or similar equipment
<div style="border: 1px solid black; padding: 2px; display: inline-block;">MIC</div>	Remote MIC for voice evacuation system
<div style="border: 1px solid black; padding: 2px; display: inline-block;">EVAC</div>	Voice evacuation panel, from NECA 100, symbol 7.008
<div style="border: 1px solid black; padding: 2px; display: inline-block;">FATC</div>	Fire alarm terminal cabinet, from NECA 100, symbol 7.009
<div style="border: 1px solid black; padding: 2px; display: inline-block;">FCS</div>	Fire command system
<div style="border: 1px solid black; padding: 2px; display: inline-block;">FACU</div>	Fire alarm control unit
<div style="border: 1px solid black; padding: 2px; display: inline-block;">SAP</div>	Sprinkler alarm panel
<div style="border: 1px solid black; padding: 2px; display: inline-block;">RP</div>	Relay alarm panel
<div style="border: 1px solid black; padding: 2px; display: inline-block;">DGP</div>	Data gathering panel
<div style="border: 1px solid black; padding: 2px; display: inline-block;">AMP</div>	Amplifier rack

Appendix C: Signal Initiating Devices & Switch Symbols

Table 17: Signal Initiating Devices & Switches Symbols























Symbol	Description	Comments
	Manual station	Basic shape
 HL	Manual station–Halon	
 CO ₂	Manual station–Carbon dioxide	
 DC	Manual station–dry chemical	
 FO	Manual station–foam	
 WC	Manual station–wet chemical	
 P	Manual station–pull-station	
 CA	Manual station–clean agent	
 WM	Manual station–water mist	
 DL	Manual station–deluge sprinkler	
 MB	Fire alarm master box	
 DK	Drill key	
 PRE	Preaction system	
	Fire service or emergency telephone station	
 A	Fire service or emergency telephone station-accessible	
 J	Fire service or emergency telephone station-jack	
 H	Fire service or emergency telephone station-handset	
	Abort switch	Basic shape
 HL	Abort switch-Halon	
 CO ₂	Abort switch-carbon dioxide	
 DC	Abort switch-dry chemical	
 FO	Abort switch-foam	
 WC	Abort switch-wet	

Table 17: Signal Initiating Devices & Switches Symbols



































Symbol	Description	Comments
 CA	Abort switch-clean agent	
 WM	Abort switch-water mist	
 DL	Abort switch-deluge sprinkler	
 PRE	Abort switch-preaction system	
 EPO	Abort switch-emergency power off	
	Automatic detection and supervisory devices	Basic shape
	Heat detector (thermal detector)	Symbol orientation cannot be changed
 R/F	Heat detector-combination rate-of-rise and fixed temperature	
 R/C	Heat detector-rate compensation	
 F	Heat detector-fixed temperature	
 R	Heat detector-rate-of-rise only	
	Heat detector-line-type detector (heat sensitive cable)	
	Smoke/heat detector	
	Smoke detector	Symbol orientation cannot be changed
 P	Smoke detector-photoelectric products of combustion detector	
 I	Smoke detector-ionization products of combustion detector	
 BT	Smoke detector-beam transmitter	
 BR	Smoke detector-beam receiver	
 ASD	Smoke detector-air sampling	
	Smoke detector for duct	
	Gas detector	
	Flame detector	Indicate ultraviolet (UV), infrared (IR), ultraviolet/infrared (UV/IR), or visible radiation-type detectors; symbol orientation cannot be changed
 F	Flame	
 UV	Ultraviolet	

Table 17: Signal Initiating Devices & Switches Symbols

Symbol	Description	Comments
	Infrared	
	Combination ultraviolet / infrared	
	Visible radiation	
	Flow detector / switch	
	Pressure detector / switch	Specify type-water, low air, high air, and so forth; symbol orientation cannot be changed
	Lever detector / switch	Symbol orientation cannot be changed
	Tamper detector	Alternate term-tamper switch
	Valve with tamper detector / switch	
	Output relay	
	Temperature switch – high temperature	
	Temperature switch – low temperature	
<p>Note: Symbols are copied from the National Fire Protection Association Standard 170, Standard for Fire Safety and Emergency Symbols.</p>		

Appendix D: Signal Indicating Appliances & Related Equipment Symbols

















Table 18: Signal Indicating Appliance Symbols & Related Equipment Symbols		
Symbol	Description	Comments
	Mini-horn	
	Gong	
	Water motor alarm (water motor gong)	Shield optional
	Bell-vibrating	
	Bell vibrating / strobe	
	Bell-vibrating stroke gong	
	Bell-vibrating stroke gong / strobe	
	Bell-trouble	
	Bell-chime	
	Horn with light as separate assembly	
	Horn with light as one assembly	
	Rotating beacon to indicate emergency response points	
	Remote alarm indicating and test switch	
Note: Symbols are copied from the National Fire Protection Association Standard 170, Standard for Fire Safety and Emergency Symbols.		

Table 19: Related Equipment Symbols		
Symbol	Description	Comments
	Door holder	
	Addressable input module	
	Addressable output module	
Note: Symbols are copied from the National Fire Protection Association Standard 170, Standard for Fire Safety and Emergency Symbols.		

Appendix E: System Installation & Troubleshooting Tips

When installing any system applications, appliances or devices, please reference the following recommendations:

- Read and understand all instructions before proceeding.
- Follow the manufacturers' instructions.
- Never connect or disconnect wiring or circuit boards with any power applied!
- Test the panel completely before bringing it to the job site. This will eliminate the possibility of installing a defective panel.
- Perform power calculations to determine if system power supply and wiring are sufficient.
- Perform battery calculations to determine proper battery size.
- Fire circuits cannot be run in the same raceway, cable or conduit as high voltage circuits.
- When not in conduit, fire circuits should not be strapped to high voltage conduit, as electrical “noise” can interfere with the fire circuits.
- Prepare a carefully laid out drawing of the complete system, including wiring hookup. A copy of this drawing should be secured in the panel cabinet.
- Locate the panel for convenience and serviceability.
- Carefully remove the panel and any associated modules from the cabinet.
- Mount the cabinet and complete all conduit connections.
- Pull all system wiring through conduit, tag and mark wires.
- Install panel and any associated modules in cabinet.
- Check integrity of field wiring.

Before making any external circuit connections:

1. Power up the panel using only the end of line devices. The panel should be in a normal condition.
2. Power down.
3. Connect one circuit.
4. Power up, panel should be in a normal condition.
5. Repeat steps 2-4 until installation is complete.

Table 20: Troubleshooting Tips

Problem	Possible Cause / Solution
Ground Fault	<p>A wire on one of the initiating or indicating circuits is making contact to ground. Possible locations could be the chassis, conduit, or a pinched wire on a sprinkler pipe.</p> <p>Disconnect all field wiring from the panel, including back up batteries. Reinstall a set of wires one at a time, giving about a 60 - 90 seconds between re-installation. The ground fault should display and will be on that set of wires.</p>
Trouble on <u>Initiating Zone</u>	<p>Remove the wires from the zone and place the end of line resistor across the zone terminals.</p> <ul style="list-style-type: none"> • If the problem clears, it is in the wiring. If it doesn't clear, there is a problem with the panel. • If 2-wire smoke detectors are used, make sure the detector and base have been listed for use with the panel.
Trouble on <u>Indicating Zone</u>	<p>Same as for initiating zone.</p> <p>On some panels, the polarity marked on the indicating circuits is for a normal condition, polarity will reverse in an alarm condition.</p> <ul style="list-style-type: none"> • On these panels, the red wire from the indicating appliance connects to the negative terminal and the black wire connects to the positive terminal. It will look backwards but when the panel goes into alarm it will be correct. • Make sure the indicating appliances do not draw more power than the circuit can supply.
Low AC	Check the AC voltage, it must be above 102VAC.
Low Battery	Check the batteries under load. Most panels will show low battery at 23VDC.
Miscellaneous Notes:	
<ul style="list-style-type: none"> • Look for blown fuses and circuit breakers that may have tripped. • Look for diagnostic LEDs that may provide information. 	